

Guidance 1000A Controllers

User Manual

Part Number 609738, Revision A



Brooks Automation

Information provided within this document is subject to change without notice, and although believed to be accurate, Brooks Automation assumes no responsibility for any errors, omissions, or inaccuracies.

AcuLigner™, Advan Tag™, AutoTeach™, ATR™, AXM™, BiSymmetrik™, CenterSmart™, Crate to Operate™, CrossingConnect™, DARTS™, Enerta™, e-RMA™, e-Spares™, e-Volution™, Falcon™, FIXLOAD™, FrogLeg™, GuardianPro™, Independent Twin Linear Exchange™, InCooler™, InLigner™, Isoport™, ITLX™, Jet™, Jet Engine™, LEAP™, LeapFrog™, LowProfile™, LPT™, M2 Nano™, Marathon 2, Marathon Express, PASIV™, Pathway™, PowerPak™, PowerTools™, PuroMaxx™, QuadraFly™, Radius™, Radiant™, Radiant Express™, Reliance™, Reliance ATR™, RetroEase™, SCARA™, SmartPM™, SMIF-INX™, SMIF-LPT™, SPOTLevel™, The New Pathway to Productivity™, Time Optimized Trajectory™, Time Optimal Trajectory™, Time Optimized Path™, TopCooler™, TopLigner™, VacuTran™, VersaPort™, WaferEngine™, LEAP™, Pathway™, GIO, GSB, Guidance 6600, Guidance 6430, Guidance 6420, Guidance 6410, Guidance 6000, Guidance 3400, Guidance 3300, Guidance 3200, Guidance 2600, Guidance 2400, Guidance 2300, Guidance 2200, Guidance 1400, Guidance 1300, Guidance 1200, Guidance 0200 Slave Amplifier, Guidance 0006, Guidance 0004, Guidance Controller, Guidance Development Environment, GDE, Guidance Development Suite, GDS, Guidance Dispense, Guidance Input and Output Module, Guidance Programming Language, GPL, Guidance Slave Board, Guidance System, Guidance System D4/D6, PreciseFlex™ 300, PreciseFlex™ 400, PreciseFlex™ 3400, PreciseFlex™ 1300, PreciseFlex™ 1400, PreciseFlex™ DD4, PreciseFlex™ DD6, PreciseFlex™ DDR, PreciseFlex™ G5400, PreciseFlex™ G5600, PreciseFlex™ G6400, PreciseFlex™ G6410, PreciseFlex™ G6420, PreciseFlex™ G6430, PreciseFlex™ G6600, PreciseFlex™ GSBP Slave Amp, PreciseFlex™ PFD0, PrecisePlace 100, PrecisePlace 0120, PrecisePlace 0130, PrecisePlace 0140, PrecisePlace 1300, PrecisePlace 1400, PrecisePlace 2300, PrecisePlace 2400, PrecisePower 300, PrecisePower 500, PrecisePower 1000, PrecisePower 2000, PreciseVision, and RIO logos are trademarks of Brooks Automation.

Fusion®, Guardian®, MagnaTran®, Marathon®, Razor®, Spartan®, Vision®, Zaris®, and the Brooks and design logo are registered U.S. trademarks of Brooks Automation.

All other trademarks are properties of their respective owners.

© 2024 Brooks Automation. All rights reserved. The information included in this manual is proprietary information of Brooks Automation, and is provided for the use of Brooks customers only and cannot be used for distribution, reproduction, or sale without the express written permission of Brooks Automation.

This technology is subject to United States export Administration Regulations and authorized to the destination only; diversion contrary to U.S. law is prohibited.

<p>Brooks Automation 15 Elizabeth Drive Chelmsford, MA 01824-2400 Tel: +1 978-262-2400 Fax: +1 978-262-2500</p>	<p>Brooks Automation, PreciseFlex Collaborative Robots 201 Lindbergh Avenue Livermore, CA 94551 Tel: +1-408-224-2838</p>
--	---



Worldwide Headquarters

15 Elizabeth Drive
Chelmsford, MA 01824 U.S.A.

Brooks Automation, PreciseFlex Collaborative Robots

201 Lindbergh Avenue
Livermore, CA 94551 U.S.A

Technical Support

Location	Contact	Website
North America	+1-800-447-5007 (Toll-Free) +1-978-262-2900 (Local) +1-408-224-2838 (PreciseFlex™)	
Europe	support_preciseflex@brooksautomation.com	
Japan	+81 120-255-390 (Toll Free) +81 45-330-9005 (Local)	
China	+86 21-5131-7066	http://www.brooks.com/
Taiwan	+886 080-003-5556 (Toll Free) +886 3-5525258 (Local)	
Korea	1800-5116 (Toll Free)	
Singapore	+65 1-800-4-276657 (Toll Free) +65 6309 0701 (Local)	

General Emails

Division	Email Address
Sales	sales_preciseflex@brooksautomation.com
Technical Support	support_preciseflex@brooksautomation.com
Technical Publications	Technical.Publications@brooksautomation.com

Revision History

Revision	ECO	Date	Action	Author
A	EC147366	08/04/2023	Released manual at Rev. A to follow standard Brooks technical publication styles.	M. Ashenfelder

Table of Contents



1. Safety	1
Safety Setup	1
Authorized Personnel Only	1
Explanation of Hazards and Alerts	2
Safety Text	2
Safety Icons	2
Signal Words and Color	2
Alert Example	3
General Safety Considerations	4
Mechanical Hazards	6
Electrical Hazards	6
Emergency Stop Circuit (E-Stop)	8
Recycling and Hazardous Materials	8
2. Introduction to the Hardware	9
System Overview	9
System Diagram	11
System Components	12
Guidance 1000A Controllers	12
Low-Voltage Power Supply and Guidance Controllers	13
Remote Front Panel, E-Stop Box and Manual Control Pendant	14
Remote IO Module	15
Machine Vision Software and Cameras	16
Status LED and Status Output Signal	16
Machine Safety	17
Voltage and Power Considerations	17
E-Stop Stopping Time and Distance	18
Safety Standards Reference Material	18
Standards Compliance and Agency Certifications	19
Moving Machine Safety	19
3. Installation Information	21
Heat Sinking and Mounting	21
Recommended Motor and Encoder Wiring	24
Wiring Overview	24
Motor Cables	24
Motor Wiring Path	25
Encoder Considerations	26
Encoder Cables	26
Encoder Wiring and Pin Assignments	27
4. Hardware Reference	28
Guidance Controller Assemblies and Interfaces	28
Connecting Power and Enabling Motor Power	29
Controller Connectors	32
Controller Connectors: Overview	32

Brake Release Connector	33
Digital Input and Output Signals	34
Encoder Interfaces	37
Ethernet Interface	38
Motor Interfaces	39
Motor Power/Encoder Battery Input Connector	40
Motor Power On/24VDC IN	41
Processor Board (MIDS4) Jumpers	42
Remote Front Panel/Secondary RS-232 & RS-485 Port Connector	45
Primary RS-232 Serial Interface	46
RS-485 Serial Interface	47
Status LED and Status Output Signal Connector	48
Low-Voltage Power Supply and G1000A Controllers	50
5. Third Party Equipment	52
Third Party Equipment: Overview	52
Panasonic A4 Serial Incremental/Absolute Encoder	52
Tamagawa Serial Incremental/Absolute Encoder	54
Yaskawa Sigma II/III Serial Absolute Encoder	55
Nikon A / Sanyo Denki Serial Absolute Encoders	57
EnDat / SII / BiSS Serial Absolute Encoders	58
Appendices	59
Appendix A: Product Specifications	59
Guidance 1000A Controller Specifications	59
Guidance Controller Environmental Specifications	62
Appendix B: Frequently Asked Questions	63

1. Safety

Safety Setup

Brooks uses caution, warning, and danger labels to convey critical information required for the safe and proper operation of the hardware and software. Read and comply with all labels to prevent personal injury and damage to the equipment.

 DANGER Read the Safety Chapter	
<p>Failure to review the <i>Safety</i> chapter and follow the safety warnings can result in serious injury or death.</p> <ul style="list-style-type: none">• All personnel involved with the operation or maintenance of this product must read and understand the information in this safety chapter.• Follow all applicable safety codes of the facility as well as national and international safety codes.• Know the facility safety procedures, safety equipment, and contact information.• Read and understand each procedure before performing it.	

Authorized Personnel Only

This product is intended for use by trained and experienced personnel. Operators must comply with applicable organizational operating procedures, industry standards, and all local, regional, national, and international laws and regulations.

Explanation of Hazards and Alerts

This manual and this product use industry standard hazard alerts to notify the user of personal or equipment safety hazards. Hazard alerts contain safety text, icons, signal words, and colors.

Safety Text

Hazard alert text follows a standard, fixed-order, three-part format.





- Identify the hazard
- State the consequences if the hazard is not avoided
- State how to avoid the hazard.

Safety Icons

- Hazard alerts contain safety icons that graphically identify the hazard.
- The safety icons in this manual conform to ISO 3864 and ANSI Z535 standards.

Signal Words and Color

Signal words inform of the level of hazard.

	<p>Danger indicates a hazardous situation which, if not avoided, will result in serious injury or death.</p> <p>The Danger signal word is white on a red background with an exclamation point inside a yellow triangle with black border.</p>
	<p>Warning indicates a hazardous situation which, if not avoided, could result in serious injury or death.</p> <p>The Warning signal word is black on an orange background with an exclamation point inside a yellow triangle with black border.</p>
	<p>Caution indicates a hazardous situation or unsafe practice which, if not avoided, may result in minor or moderate personal injury.</p> <p>The Caution signal word is black on a yellow background with an exclamation point inside a yellow triangle with black border.</p>
	<p>Notice indicates a situation or unsafe practice which, if not avoided, may result in equipment damage.</p> <p>The Notice signal word is white on blue background with no icon.</p>



Alert Example

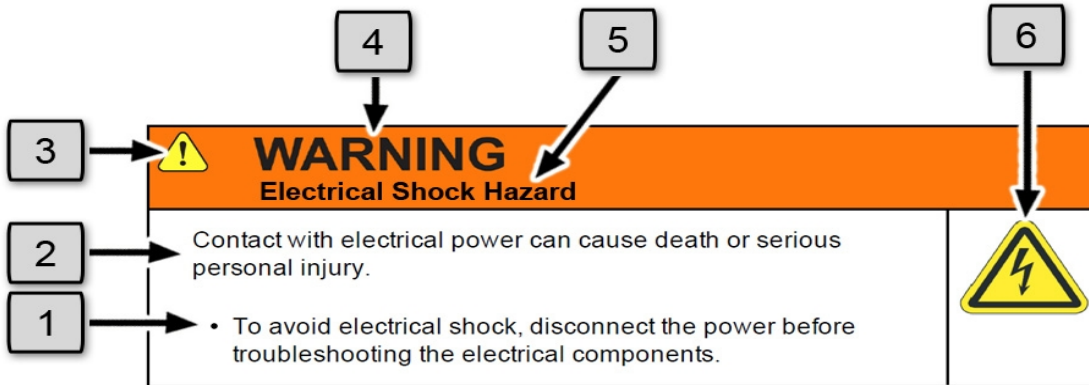

The following is an example of a Warning hazard alert.







Number	Description
1.	How to Avoid the Hazard
2.	Source of Hazard and Severity
3.	General Alert Icon
4.	Signal Word
5.	Type of Hazard
6.	Hazard Symbol(s)



General Safety Considerations



 WARNING Software	
<p>Software is not safety rated. Unplanned motion can occur as long as power is supplied to the motors. Maximum torque could be momentarily applied that may cause equipment damage or personal injury.</p> <ul style="list-style-type: none">• Only operate the robot with its covers installed.• Guarantee that safety controller features are in place (for example, an emergency stop button and protective stop).• Regularly test safety components to prove that they function correctly.	 



 WARNING Robot Mounting	
<p>Before applying power, the robot must be mounted on a rigid test stand, secure surface, or system application. Improperly mounted robots can cause excessive vibration and uncontrolled movement that may cause equipment damage or personal injury.</p> <ul style="list-style-type: none">• Always mount the robot on a secure test stand, surface, or system before applying power.	



 WARNING Do Not Use Unauthorized Parts	
<p>Using parts with different inertial properties with the same robot application can cause the robot's performance to decrease and potentially cause unplanned robot motion that could result in serious personal injury.</p> <ul style="list-style-type: none">• Do not use unauthorized parts.• Confirm that the correct robot application is being used.	

 WARNING Magnetic Field Hazard	
<p>This product contains magnetic motors that can be hazardous to implanted medical devices, such as pacemakers, and cause personal harm, severe injury, or death.</p> <ul style="list-style-type: none">• Maintain a safe working distance of 30 cm from the motor when with an energized robot if you use a cardiac rhythm management device.	



 CAUTION Unauthorized Service	
<p>Personal injury or damage to equipment may result if this product is operated or serviced by untrained or unauthorized personnel.</p> <ul style="list-style-type: none">• Only qualified personnel who have received certified training and have the proper job qualifications are allowed to transport, assemble, operate, or maintain the product.	



 CAUTION Damaged Components	
<p>The use of this product when components or cables appear to be damaged may cause equipment malfunction or personal injury.</p> <ul style="list-style-type: none">• Do not use this product if components or cables appear to be damaged.• Place the product in a location where it will not get damaged.• Route cables and tubing so that they do not become damaged and do not present a personal safety hazard.	

 CAUTION Inappropriate Use	
<p>Use of this product in a manner or for purposes other than for what it is intended may cause equipment damage or personal injury.</p> <ul style="list-style-type: none">• Only use the product for its intended application.• Do not modify this product beyond its original design.• Always operate this product with the covers in place.	

 CAUTION Seismic Restraint	
<p>The use of this product in an earthquake-prone environment may cause equipment damage or personal injury.</p> <ul style="list-style-type: none"> The user is responsible for determining whether the product is used in an earthquake prone environment and installing the appropriate seismic restraints in accordance with local regulations. 	



Mechanical Hazards



 WARNING Automatic Movement	
<p>Whenever power is applied to the product, there is the potential for automatic or unplanned movement of the product or its components, which could result in personal injury.</p> <ul style="list-style-type: none"> Follow safe practices for working with energized products per the facility requirements. Do not rely on the system software or process technology to prevent unexpected product motion. Do not operate the product without its protective covers in place. While the collaborative robotics system is designed to be safe around personnel, gravity and other factors may present hazards and should be considered. 	 



 CAUTION Vibration Hazard	
<p>As with any servo-based device, the robot can enter a vibratory state resulting in mechanical and audible hazards. Vibration indicates a serious problem. Immediately remove power.</p> <ul style="list-style-type: none"> Before energizing, ensure the robot is bolted to a rigid metal chamber or stand. 	

Electrical Hazards

Refer to the specifications of the *Guidance Controller Quick Start Guide* for the electrical power.

 DANGER Electrical Shock Hazard	
<p>Contact with electrical power can cause personal harm and serious injury.</p> <ul style="list-style-type: none">• To avoid electrical shock, disconnect the power before troubleshooting the electrical components.• Check the unit's specifications for the actual system power requirements and use appropriate precautions.• Never operate this product without its protection covers on.	



 WARNING Electrical Burn	
<p>Improper electrical connection or connection to an improper electrical supply can result in electrical burns resulting in equipment damage, serious injury, or death.</p> <ul style="list-style-type: none">• Always provide the robot with the proper power supply connectors and ground that are compliant with appropriate electrical codes.	

 WARNING Electrical Fire Hazard	
<p>All energized electrical equipment poses the risk of fire, which may result in severe injury or death. Fires in wiring, fuse boxes, energized electrical equipment, computers, and other electrical sources require a Class C extinguisher.</p> <ul style="list-style-type: none">• Use a fire extinguisher designed for electrical fires (Class C in the US and Class E in Asia).• It is the facility's responsibility to determine if any other fire extinguishers are needed for the system that the robot is in.	

NOTICE	
<p>Improper handling of the power source or connecting devices may cause component damage or equipment fire.</p> <ul style="list-style-type: none">• Connect the system to an appropriate electrical supply.• Turn off the power before servicing the unit.• Turn off the power before disconnecting the cables.	

Emergency Stop Circuit (E-Stop)

The integrator of the robot must provide an emergency stop switch.

 WARNING Emergency Stop Circuit	
<p>Using this product without an emergency stop circuit may cause personal injury.</p> <ul style="list-style-type: none">• Customer is responsible for integrating an emergency stop circuit into their system.• Do not override or bypass the emergency stop circuit.	

Recycling and Hazardous Materials

Brooks Automation complies with the EU Directive 2002/96/EU Waste Electrical and Electronic Equipment (WEEE).

The end user must responsibly dispose of the product and its components when disposal is required. The initial cost of the equipment does not include cost for disposal. For further information and assistance in disposal, please email Brooks Automation Technical Support at support@preciseflex@brooksautomation.com.

2. Introduction to the Hardware

System Overview

The Guidance family of motion controllers incorporates a distributed control architecture that utilizes Ethernet for real-time communication. Each motion controller on the network includes a motion/vision processor and one or more optional motor drives. Up to 16 motion controllers can be placed on a single network. The controllers can be wired in a daisy-chain topology to minimize the number of wires in a machine although a star topology has certain advantages and is also supported.

The Guidance 1000A Controllers are the second generation of the smallest, most economical family of PreciseFlex™ motion controllers. In comparison to the first generation Guidance 1000 Controllers, this new generation supports up to 200 W motors (instead of just 100 W motors) and includes additional standard features such as a manual control pendant interface, dual E-stop signal inputs, and a RS-485 communication interface. As compared to the Guidance 2000/3000, these controllers are designed to save additional cost and space for applications that only require lower power servo motors. Like the Guidance 2000/3000, the Guidance 1000A controllers offer the same powerful, compatible language options, web interface, geometric (“kinematic”) modules and extensive motion control capabilities. Since the Guidance 1000A Controllers are designed for low voltage/lower power motors, they include only those safety signals that are required these types of motors. However, the Guidance 1000A can be used in combination with Guidance 2000/3000 controllers to satisfy all safety requirements for systems with a mixture of high and low power motors.

The Guidance 1000A Controllers include integrated motor drives. These controllers require an external 24VDC supply for logic and IO and an external motor power supply. The motor power supply voltage can range from 12VDC to 48VDC, which is suitable for most low power motors. These motion controllers are very compact and are intended to be placed near the point of use, which in many cases means they will be installed inside the machine rather than in an external control cabinet. The G1000A series can include two, three or four integrated motor drives (the Guidance 1200A, 1300A or 1400A).

Motion axes can be grouped into “robots,” which are defined by a geometric (“kinematic”) model. A “robot” has a master controller that executes the kinematic model and sends out axes position commands to any slave controllers. The logical grouping of axes into robots is independent of the physical configuration of the motion controllers. For example, two (2) single-axis controllers and one

4-axis controller can be logically grouped into a 6-axis robot, with one of the controllers designated as the master, and the other two (2) as slaves. Motion can also be coordinated among robots on the same network. For example a 4-axis robot can be coordinated with a 2-axis robot. The Guidance 1000A can be run as a standalone robot controller or it can be a slave controller in a network of controllers where the master is a Guidance 2000/3000 or another Guidance 1000A.

Each Guidance Controller can have several types of peripherals attached to it. These include cameras, remote I/O, and a hardware manual control pendant.

The controller includes a web based operator interface that is viewed via a standard browser. This interface is used for configuring the system, starting and stopping execution, and monitoring its operation. The web interface can be accessed over a local network or remotely via the Internet. This remote interface is of great benefit in system maintenance and debugging. It is highly recommended that first time users read the *Setup and Operation Quick Start Guide*, PN 0000-DI-00010, for instructions on interfacing a PC to a controller via the web interface and for general operating instructions.

The controller is programmed by means of a PC connected through Ethernet. There are three (3) programming modes: a Digital IO (PLC) mode, an Embedded Language mode, and a PC Control mode. When programmed in the PLC or Embedded Language mode, the PC can be removed after programming is completed and the controller will operate standalone. A PC is required for operation in the PC Control mode. For a description of the embedded language and its development environment, refer to the *Guidance Programming Language, Introduction to GPL* (PN GPL0-DI-S0010) and the *Guidance Development Environment, Introduction and Reference Manual* (PN GDE0-DI-S0010).

The controller is designed to operate with an optional, easy-to-use machine vision software package, "PreciseVision." This vision system can be executed in a PC connected through Ethernet or (in the future) in the motion controller. It provides a complete set of image-processing, measurement, inspection, and object finder tools. For more information on vision, refer to the *PreciseVision Machine Vision System, Introduction and Reference Manual* (PN PVS0-DI-S0010).

System Diagram

The Guidance 1000A system diagram is shown in Figure 2-1. The controller consists of a CPU board (MIDS4) and a motor power amplifier board (4ALV4A or 4ALV4B).

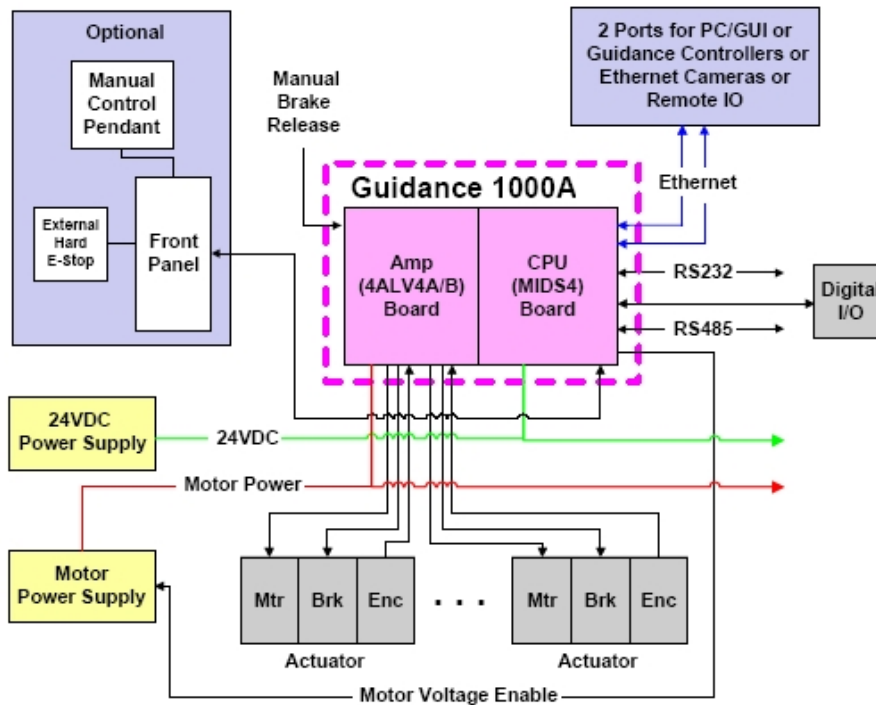

Figure 2-1: Guidance 1000A System Diagram

This unit can operate as a standalone controller or as a master or slave within a controller network. It includes interfaces to a wide range of motors and encoders, serial devices via RS-232 and RS-485, other equipment and sensors via simple digital input and output signals, and a remote front panel. The remote front panel is optional and is not required for the system to operate. For simple systems, an E-Stop button or manual control pendant with an E-stop can be directly connected to the controller via the front panel interface.

An Ethernet switch on the CPU board supports two (2) Ethernet ports that can be connected to a PC, other Guidance Controllers, cameras, or remote IO boards. The PC can serve as the system GUI and can provide real-time commands to the controller.

All of the extensive communication features of this controller are described in detail in the following chapters.

System Components

Guidance 1000A Controllers

The Guidance 1000A controllers consist of a high-performance processor board (a standard or enhanced MIDS4), a motor power amplifier board (a 4ALV4A or 4ALV4B), and a sheet metal heat spreader mounting plate. These open frame controllers include interfaces for 2, 3, or 4 motors and encoders, and are referred to as G1200A, G1300A, G1400A controllers, respectively.

The MIDS4 processor board includes a 400 Mhz high-performance, low-power CPU, at least 8 MB of dynamic RAM and at least 16 MB of nonvolatile flash disk for storage of the OS, firmware and user program and data. It also includes the following standard interfaces: two 10/100 Mbit Ethernet ports; a RS-232 port; a RS-485 port, four general purpose optically isolated digital inputs; four (4) general purpose optically isolated digital outputs; a motor power enable signal; and a simplified remote front panel interface. The front panel interface includes: a second RS-232 port for communicating with a manual control pendant (MCP) and dual E-Stop signal inputs. The "enhanced" version of the MIDS4 board includes additional hardware support that is required for selected absolute encoders and other special features.

The two (2) motor power amplifier boards (the 4ALV4A or 4ALV4B) are very similar. The "A" version was designed for use in general motion control applications and includes easy-to-use readily available Amp Micro Mate-N-Lok connectors. The "B" version was specifically designed for use in the PreciseFlex™ 400 robot and includes special "Flat Flexible Cable" (FFC) connectors. FFC is a miniaturized form of ribbon cable that can be rolled in a small diameter "clock spring" to permit transmission of power and signals through small rotary axes. Due to the small pin and conductor sizes permitted for FFC, the "B" amplifiers have a somewhat reduced current rating compared to the "A" amplifiers. Consequently, most customers will be primarily interested in the G1000A (Figure 2-2) line of controllers.



 DANGER Electrical Shock Hazard	
<p>Contact with electrical power can cause serious personal injury or death. The Guidance 1000A Controllers are powered by 24VDC and can contain voltages up to 48 VDC to drive the motors.</p> <ul style="list-style-type: none">• Mount this product in a cabinet or machine chassis that is not accessible when AC line power is on.	

Figure 2-2 shows the Guidance 1000A, which includes the 4ALV4A motor power amplifier (lower board) that has Amp Micro Mate-N-Lok connectors.

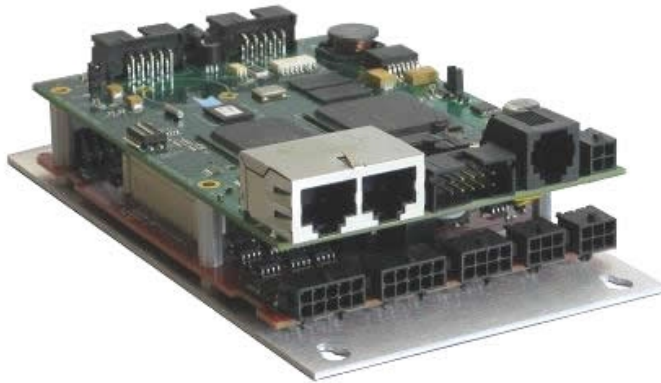



Figure 2-2: Guidance 1000A Controller

Low-Voltage Power Supply and Guidance Controllers

The Guidance Controllers require 0.7 amps of 24VDC power for its logic circuits and 1.3 amps for IO power, for a minimum of 2 Amps. For applications using remote IO, Ethernet cameras or several motor brakes, Brooks recommends a total of 4 Amps. This voltage may be supplied by a user power supply or a 24VDC power supply may be purchased from Brooks.

 DANGER Electrical Shock Hazard	
<p>Contact with electrical power can cause serious personal injury or death. The 24VDC logic power supply is an open frame electrical device that has exposed unshielded high voltage pins, components and surfaces. In addition, the heat sinks on the 24VDC Power Supply are not grounded and expose high voltage levels.</p> <ul style="list-style-type: none">• Mount this product in a cabinet or machine chassis that is not accessible when AC line power is on.	

A commercially available 125-watt, 24VDC Power Supply, Mean Well P/N PPS-125-24, with AC input from 90V to 264V, is shown in [Figure 2-3](#).

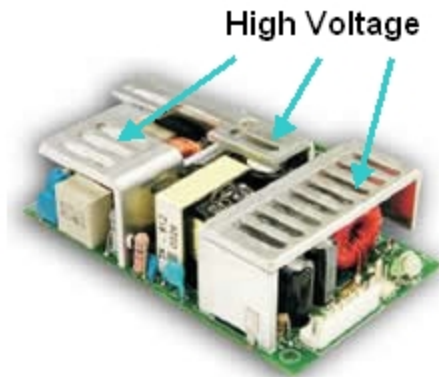

Figure 2-3: 125-watt, 24VDC Power Supply

Remote Front Panel, E-Stop Box and Manual Control Pendant

The Guidance 1000A include an interface to an optional remote front panel. This interface provides dual E-Stop safety signals and a RS-232 port for use with a Manual Control Pendant (MCP). If the front panel interface is not utilized, the following pins on the front panel connector must be jumpered in order for the system to properly operate. (All controllers are shipped with these jumpers installed.)

1-2, 3-4

See the Controller Hardware Reference section for a detailed description of the Remote Front Panel interface signals.

For users that wish to have an E-Stop button for their controller without a remote front panel, Brooks sells an E-Stop Box with a connector pigtail that plugs into the Remote Front Panel connector.

For users who want to have an MCP ([Figure 2-4](#)) that can be carried around the workcell, Brooks offers two (2) hardware MCPs. The standard unit weighs 0.567 kg and includes an E-Stop button. For those applications where an operator must be inside the working volume of the robot while teaching, an alternate teach pendant with an E-Stop button and a 3-position hold-to-run button is also available. The PreciseFlex MCP's come with a 25-pin DSub connector that directly attaches to some PrecisePlace robots and the Guidance Systems. A 25-pin DSub to 10-pin connector adaptor cable is available for plugging the MCP into the Remote Front Panel connector of a Guidance 1000A Controller.



Figure 2-4: Manual Control Pendant

Remote IO Module

For applications that require additional IO capability beyond the standard functions provided with every Guidance Controller, a PreciseFlex Remote IO (RIO) module may be purchased. The RIO interfaces to any Guidance Controller via 10/100 Mb Ethernet and requires 24VDC power. Up to four (4) Rids can be connected to a controller.

The basic RIO includes the following:

- 32 isolated digital input signals
- 32 isolated digital output signals
- One RS-232 serial line

An enhanced version of the RIO adds 4 (four) analog input signals, a second RS-232 port, and one RS-422/485 serial port. In addition, expansion boards will be offered in the future that cost-effectively add additional isolated digital inputs and outputs in groups of 32 each to the basic RIO. The Enhanced RIO module is displayed in [Figure 2-5](#).

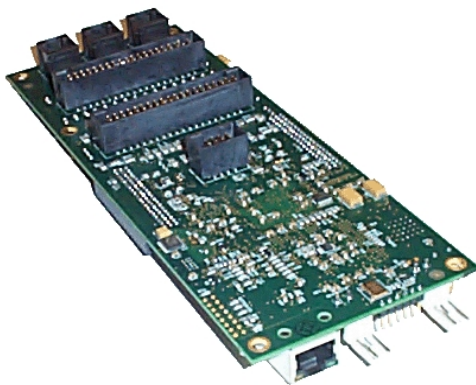



Figure 2-5: Enhanced RIO Module

 DANGER Electrical Shock Hazard	
<p>Contact with electrical power can cause serious personal injury or death. The RIO contains unshielded 24VDC signals and pins.</p> <ul style="list-style-type: none"> • Mount this product in a cabinet or machine chassis that is not accessible when power is turned on. 	

Machine Vision Software and Cameras

All Guidance Controllers support the PreciseVision machine vision system. This is a vision software package that can run either on a PC for higher performance applications, or in the motion controller processor for simple applications (available in the future).

When PreciseVision is executed on a PC, it communicates with the motion controller via Ethernet and with cameras via either Ethernet or USB connections. Vendors such as IDS Imaging offer a variety of Ethernet machine vision cameras and industrial USB cameras.

Status LED and Status Output Signal

The controller includes a Status LED on its top board and a Status Digital Output Signal that indicate the execution state of the controller. The redundant digital output signal permits an external LED to be driven if the controller is embedded and the on-board LED is not visible.

To configure the Status Digital Output Signal or any general purpose digital output to blink in synchronization with the Status LED, the "Power State DOUT" (DataID 235) must be set equal to the signal's channel number.

The execution conditions that are indicated by the LED and the output signal (if configured) are described in [Table 2-1](#).

Table 2-1: Execution Conditions Indicated by LED & Output Signal

LED/Signal State	System Status	Description
Continuously Off	(1) Logic power off or (2) CPU crashed	Normally indicates that 24VDC logic power is off. In rare instances, indicates that the controller has crashed due to a system hardware or software error. The processor may be executing the firmware debugger, dBug.

LED/Signal State	System Status	Description
Continuously On	(1) Booting or (2) CPU crashed	Typically indicates that 24VDC logic power is on and the controller is executing its start-up boot sequence. If the LED turns on continuously after it has been blinking, the processor has crashed due to a system hardware or software error. The processor may be executing the firmware debugger, dBug.
Blinks 1 time per second	Normal operation, motor power off	The controller is executing in its standard operating mode and motor power is disabled.
Blinks 4 times per second	Normal operation, motor power on	The controller is executing in its standard operating mode and motor power is enabled.
Blinks 8 times per second	CPU overheating	The processor is overheating, motor power is off and the user has five minutes to save any programs or data. After 5 minutes, the processor will shut down and needs to be rebooted.

Machine Safety

Voltage and Power Considerations

The Guidance 1000A Controllers require two DC power supplies: a 24VDC power supply for the logic and user IO, and a motor power supply. The motor power supply must provide the controller with a voltage between 12VDC and 48VDC.

DANGER

Electrical Shock Hazard

<p>Contact with electrical power can cause serious injury or death. The standard 24VDC power supply is an open frame electrical device that contains unshielded high voltage pins, components and surfaces. The Guidance 1000A is powered by 24VDC and can contain voltages up to 48VDC to drive the motors</p> <ul style="list-style-type: none"> Mount this product in a cabinet or machine chassis that is not accessible or has its top cover installed when AC line power is on. 	
--	---

The PreciseFlex controller can monitor motor power through its data logging function. Intermittent power dropouts can be detected by setting a trigger in the data logger which can record and time-stamp power fluctuations.

E-Stop Stopping Time and Distance

The control system responds to two types of E-stops: a "Soft E-Stop" and a "Hard E-Stop."

Soft E-Stop

A "Soft E-Stop" initiates a rapid deceleration of all robots currently in motion and generates an error condition for all programs that are attached to a robot. This method can be used to quickly halt all robot motions in a controlled fashion when an error is detected.

This function is similar to a "Hard E-Stop" except that a soft E-Stop leaves motor power enabled and is therefore applicable to less severe error conditions. Leaving motor power enabled is beneficial in that it prevents the robot axes from sagging and does not require motor power to be re-enabled before program execution and robot motions are resumed. This method is similar to a "Rapid Deceleration" except that a Rapid Deceleration only affects a single robot and no program error is generated.

Hard E-Stop

A "Hard E-Stop" is generated by one of several hardware E-Stop inputs and causes motor power to be disabled. However, there is a firmware parameter that can delay disabling motor power for a fixed amount of time after a hard E-Stop signal is asserted. This delay is nominally set at 0.5 seconds and may be adjusted by an operator with administrator privileges. On the web based operator interface menu, go to **Setup > Parameter Database > Controller > Operating Mode** and set parameter DataID 267 to the desired delay. If this delay is set to 0, the motor power relay will be disabled within 1 ms after an input signal is asserted.

If an axis does not have a mechanical brake and motor power is disabled while the axis is moving, it may coast for a significant distance. Leaving the motor power enabled for 0.5 sec allows the servos to perform a rapid controlled deceleration of these axes. For example, if a linear axis is moving at a speed of 1000 mm/sec and the servos decelerate it at 0.4G (3920 mm/sec²), the axis will reach a full stop in 0.26 sec after having only traveled a distance of 127 mm.

If a gravity loaded axis has a mechanical brake but the brake takes some time to engage, if motor power is disabled immediately when a Hard E-Stop is signaled, the axis will drop before the brake takes effect. In this case, a short delay after the brake is actuated and before disabling motor power will allow time for the brake to engage and will prevent the axis from dropping.

Safety Standards Reference Material

PreciseFlex controllers can operate computer-controlled mechanisms that are capable of moving at high speeds and exerting considerable force. Like all robot and motion systems and most industrial equipment, they must be treated with respect by the user and the operator.

This manual should be read by all personnel who operate or maintain PreciseFlex™ systems, or who work within or near the work cell.

Read the *American National Standard for Industrial Robot Systems – Safety Requirements*, published by the Robotic Industries Association (RIA) in cooperation with the American National Standards Institute. The publication, ANSI/RIA R15.06, contains guidelines for robot system installation, safeguarding, maintenance, testing, startup, and operator training. Also read the International Standard IEC 204 or the European Standard EN 60204, *Safety of Machinery – Electrical Equipment of Machines*, and ISO 10218 (EN 775), *Robots for Industrial Environments – Safety Requirements*, particularly if the country of use requires a CE-certified installation.

Standards Compliance and Agency Certifications

The PreciseFlex Guidance Controllers are intended for use with other equipment and are considered a subassembly rather than a complete piece of equipment on their own. They meet the requirements of these standards:

- EN 61000-4-2 Electrostatic Discharge (8 KV air, 6 KV contact)
- EN 61000-4-3 Radiated Electromagnetic Field Immunity (3 V/m, 27-500 MHz)
- EN 61000-4-4 Electrical Fast Transient/Burst Immunity (2 KV)
- EN 61000-4-5 Surge Immunity Test (1 KV differential, 2 KV common mode)
- EN 61000-4-6 Conducted Disturbances Immunity (RF: 150 KHz – 80 MHz)
- EN 50081-2 Electromagnetic Compatibility General Emissions Standard

To maintain compliance with the above standards the controller must be installed and used in accordance with the regulations of the standards, and in accordance with the instructions in this user's guide.

In addition to the above standards, the Guidance Controllers have been designed to comply with the following agency certification requirements:

- CE
- CSA
- UL
- ANSI/RIA R15.06 Safety Standard

Moving Machine Safety

The PreciseFlex Guidance Controllers drive robots that can operate in Manual Control Mode, in which an operator directly controls the motion of the robot, or in Computer Control Mode, in which the robot operation is automatic. Manual Control Mode is often used to teach locations in the robot workspace. The robot's speed should be limited in Manual Control Mode to a maximum of 250 mm per second for safety as required by EN ISO 10218-1-2007.

This speed setting can be easily confirmed using the "Virtual Pendant" in the Web interface. After enabling power and homing the robot, select "Virtual Pendant" in the Web Control Panels Menu, then select a manual control mode such as **World Mode**, select the **X-axis**, set the speed slider to

100%, drive the axis 250 m, and time the motion. While it is possible to set a high manual control speed, this is not recommended, and should only be done after an application risk assessment.

While some light-duty robots (like the PreciseFlex 400) can only apply moderate forces, it is always important for operators to keep their hands, arms and especially their head out of the robot's operating volume.

In Computer Mode, robots can achieve speeds of over 2000 mm/sec. During Computer Mode Operation, it is strongly recommended that operators be prevented from entering the robot work volume by safety barriers that are interlocked to the E-stop circuitry. Read the ANSI/RIA R15.06 *Safety Standard for Industrial Robots* or EN ISO 10218-2-2007, *Robots for Industrial Environments, Safety Requirements*, for information on recommended safe operating practices and enclosure design for robots of various sizes and payloads.

3. Installation Information

Heat Sinking and Mounting

The Guidance 1000A Controllers have a very small footprint but can control a substantial amount of motor power. For reliable operation, it is important that these controllers be properly mounted on a heat sink and cooled to dissipate the heat generated by the controller's power devices and high performance ICs.

The controller should be mounted to a heat sink with thermal grease and M3 by 6 mm button head cap screws. The mounting holes are shown in **Blue** in [Figure 3-1](#) with all dimensions in millimeters. If there is insufficient air flowing across the high performance ICs on the top processor board, forced air or some other means of conducting the heat away may be necessary (see below).

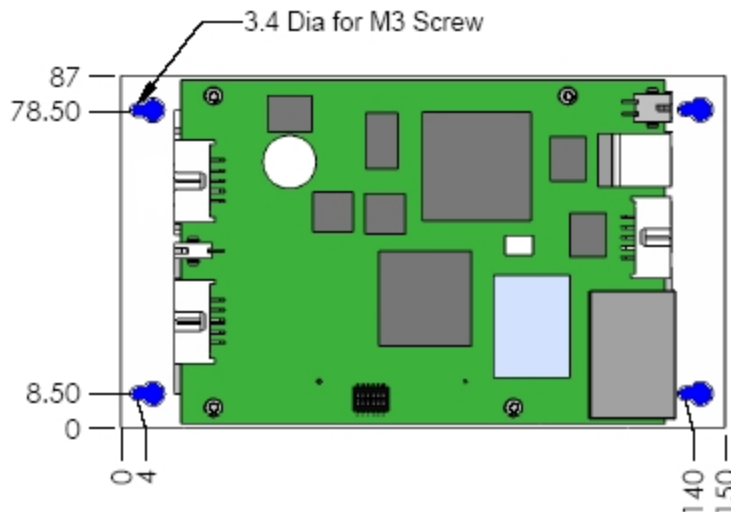

Figure 3-1: Controller Mounting Holes Shown in Blue

The size of the heat sink on which the controller should be mounted is a function of the power being dissipated. [Table 3-1](#) provides estimates of the required heat sink area and indicates whether a fan is typically required as a function of the RMS power being drawn by the controller. RMS power is best measured with a watt meter connected to the AC power line going to the power supplies for the

robot. Several inexpensive watt meters are available. For example, a “Kill-a-Watt” meter plugs into a power outlet and has a second outlet for the device being measured.

Table 3-1: Estimates of Required Heat Sink Area

Controller RMS Power	Heat Sink (Metric)	Heat Sink (English)	20 cfm Fan Required
100 Watts	0.02 m ²	6 in x 6 in	No
200 Watts	0.06 m ²	10 in x 10 in	No
300 Watts	0.10 m ²	12 in x 12 in	No
400 Watts	0.16 m ²	16 in x 16 in	Yes
500 Watts	0.20 m ²	18 in x 18 in	Yes

Note that for most robot applications, motors do not run continuously at their rated torques and rated speeds, but accelerate up and down and pause at different positions. Consequently, the RMS power drawn by the controller will typically be much less than the sum of the rated power for the motors. A general rule of thumb for guessing the typical RMS power needed for a set of motors is to add up the rated power for the motors and divide by a factor of 3 or 4. As an example, the motors for the PreciseFlex 400 robot are rated at 100W, 200W, 100W, 30W, and 26W. The total rated power for these motor is 456W. However running at full speed in a typical pick and place cycle, the PF400 consumes about 120W of RMS power when measured with a watt meter.

Another means for approximately determining the actual RMS motor power is to run the target robot application at full speed and full load and go to the motor diagnostics page in the Web Interface under **Setup > Hardware Tuning and Diagnostics/Motor Diagnostics** and note the duty cycle for each motor. The duty cycle will indicate the actual power being utilized as a percentage of each motors rated power.

In general, the thickness of the heat sink is not critical. The surface area dictates the amount of heat dissipated and the mass of the heat sink determines the time required for the heat sink to achieve a stable state. Note that the heat sink may be a robot chassis or other thermally conductive structure.

A good indication of whether the controller is being properly cooled is to monitor the CPU and amplifier temperatures after the system has operated for an hour or two at its full speed and load. These temperatures can be read via the Web interface **Control Panels > System Information > System Console > Amp Temp**. For long-term reliable operation, the CPU temperature should be 80° C or lower and the amplifier temperatures should be 80° C or lower.

If the current ambient temperature is below the expected maximum operating temperature, add the difference between the current ambient and the maximum ambient to estimate the maximum temperatures. For example, if the current ambient is 25° C and a user expects to operate at the system’s maximum ambient of 40° C, add 15° C to the readings of the CPU and amplifier temperatures to determine if the cooling is sufficient.

For applications with high duty cycles and power or limited heat sinking or high ambient temperatures, a small fan blowing through the controller will greatly reduce the controller's operating temperatures.

For OEM applications where the controller is embedded inside a robot, the CPU, FPGA, and Ethernet switch chips (the three largest chips on the top surface of the MIDS4/CPU board) can be cooled by pressing heat sinks against them using thermal material (for example 3M 5591S Thermally Conductive Interface Pads). Employing thermal conduction to transfer the heat from these high performance chips as well as from the heat spreader mounting plate to external surfaces can often eliminate the need for fans.

Figure 3-2 illustrates how this was implemented within the inner link of the PreciseFlex 400 robot.

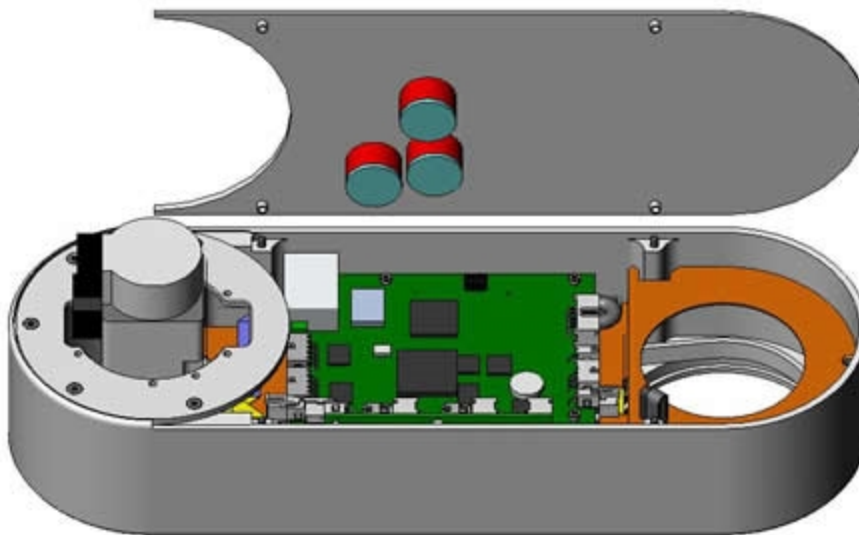

Figure 3-2: Controller Embedded Inside a PreciseFlex 400 Robot

In some systems, customers may wish to remove the bottom heat spreader mounting plate and attach the controller directly to a metal frame or chassis. In this case, care must be taken to maintain the position of the thermal pad that conducts heat from the power devices on the Motor Amplifier Board to the mounting surface.

Recommended Motor and Encoder Wiring

Wiring Overview

To achieve low power losses, the controller's motor drives are designed as switching amplifiers with edges that occur as fast as once every 100 nsec. While this aids in keeping the switching losses down, it can make receiving logic level signals from encoders and other sensors more difficult. This is because every PWM edge must charge and discharge the motor wiring capacitance. This can generate current spikes that can cause the motor frame to have ground bounce due to the inductance of the ground return back to the amplifier. This ground bounce and the coupling between motor harness wire and encoder harness wires can introduce noise into the system.

Fortunately, since the Guidance 1000A is limited to relatively low motor voltages, the problem of induced ground bounces is significantly mitigated. However, because other devices in the system may generate similar electrical noise, it is good practice to employ wiring methods that safeguard against such problems.

NOTICE

Follow the wiring guidelines in this section in order to avoid encoder quadrature errors, zero index errors, and other noise-related problems.

Motor Cables

Alpha Wire recommends the following current ratings (see [Table 3-2](#)) for wire with PVC insulation at 80° C. In general, the wire ratings should meet or exceed the RMS (rated) current of the motor and not the peak current since the primary concern is over-heating the wire due to excessive average motor currents.

Table 3-2: Current Ratings for Wire with PVC Insulation at 80° C

Wire Size AWG	28	26	24	22	20	18
Amperes	3	4	6	8	10	15

If even higher current ratings are required, Teflon or other high temperature insulation permits higher currents for a given wire size. For example, 22 AWG wire with Teflon insulation has a current rating of 13A at 200° C.

As an extra precaution, we recommend that the motor wire should be shielded and have a rating of 150 volts or more. The typical wires that are shown in [Table 3-3](#) have a 105° C rating. These wires do not have a drain wire, so a drain connection must be soldered to the shield.

Table 3-3: Wires with a 105° C Rating

	Alpha 18 AWG	SAB 22 AWG
High Flex	85803CY	7840503 5 conductor shielded cable
Moderate Flex	65803CY	
No Flex	3242	

Motor Wiring Path

Since the ground bounce of motors connected to this controller will be small due to their low voltages, the motor cables for this controller do not require ferrite beads. (“Ferrite beads” are sometimes referred to as “ferrite chokes” or “ferrite cores.”)

NOTE: If also wiring a Guidance 2000 or 3000 controller with high voltage motors, consult the wiring instruction for those controllers since their recommended wiring practices are significantly different.

[Figure 3-3](#) illustrates how the motor cable should be wired. The shield around the motor cable is optional, but a good practice to follow.

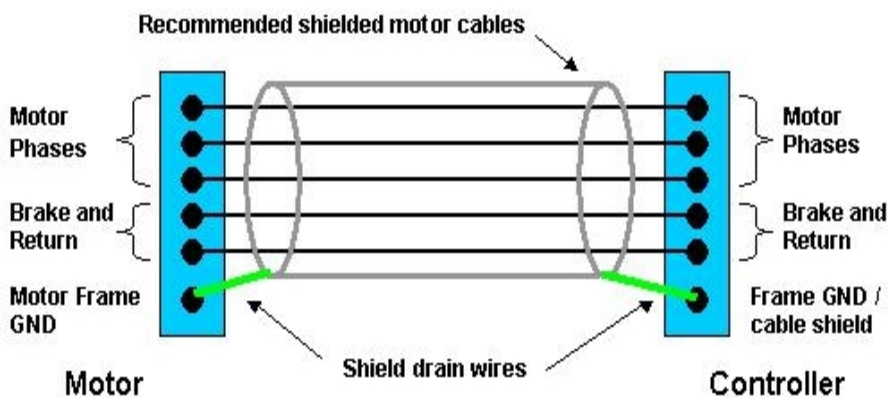

Figure 3-3: Recommended Motor Wiring

Encoder Considerations

The preferred encoder should have a differential cable driver built in. The differential signal will cancel out much of the common mode noise that encoder wiring can pick up and, when used with twisted pair wire, will cancel out the magnetic pick up from the motor harness.

Some encoders have an open collector output or an output with only a 10K pull up resistor. These encoders should only be used with a cable driver IC such as a DS26C31 mounted nearby the encoder or the encoder should be mounted within 5 feet of controller and wired with shielded cable.

If an encoder's code wheel or linear mask is made with etched metal or other conductive material, the encoder should not be used if it is mounted to any housing or chassis that has ground bounce on it. For example, if such an encoder is directly mounted to a motor frame without electric insulation, its use could result in quadrature errors and other noise problems.

Encoder Cables

It is highly recommended that the encoder cable be shielded and contain four twisted pairs with a gauge of AWG 24 or AWG 26. See [Table 3-4](#) for recommended cables.

NOTE: Unshielded non-twisted pair encoder wiring should never be run next to unshielded motor wiring or other possible noise sources.

Table 3-4: Recommended Cables

	Alpha 24 AWG	Alpha 26 AWG	Beldon 24 AWG	SAB 26 AWG
High Flex	86604CY	86504CY		07890414
No Flex	5494C 5272C		88104	

One of the twisted pairs should be used for power and ground, one pair for A+ & A-, one pair for B+ & B- and one pair for Z+ & Z- (see the next section.). Connect the shield to one of the ground pins on the controller encoder connector. On some encoders that are in a metal box with a metal shell connector, on the encoder end of the cable, connect the shield to the metal shell of the mating connector.

Encoder Wiring and Pin Assignments

Each encoder connector on the Guidance 1000A provides pins for interfacing to a differential incremental encoder or an absolute encoder. This interface can also be utilized to connect to single-ended encoders. However, it is always best to select an encoder with differential signals for the greatest noise immunity. See "Third Party Equipment: Overview" on page 52 for specific pin assignment for absolute encoders.

If a single-end encoder is connected using twisted pair wire, the low side of both ends of each twisted pair should be connected to ground, and the A-, B-, and Z- signals of the controller's differential encoder inputs should each be pulled to 5V through a 2K resistor. The A+, B+ and Z+ signals should be connected without any special modifications. For high volume OEM applications, surface mounted pull-up resistors can be installed at Brooks's factory to configure specific encoder channels for single-ended encoders. For qualified applications, contact Brooks Sales at sales_preciseflex@brooksautomation.com to discuss this option.

Due to pin limitations, if several wires must be connected to a single pin, a larger crimp pin should be used.

Figure 3-4 illustrates how to interface to a differential encoder.

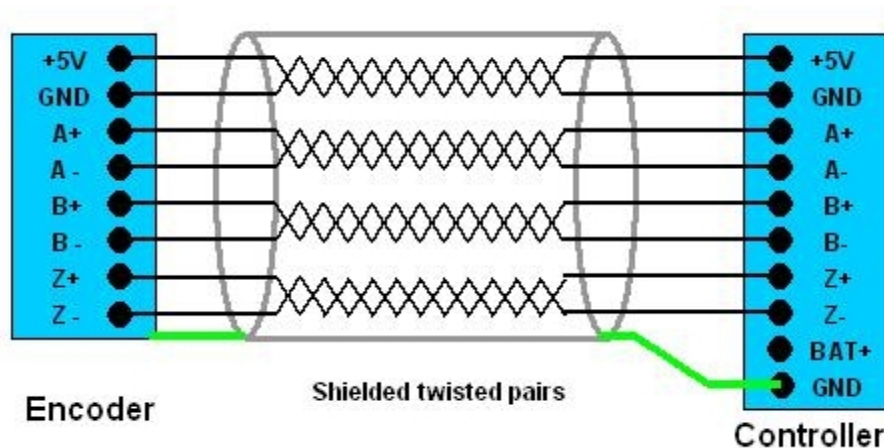

Figure 3-4: Differential Encoder Wiring

NOTE: Especially for high frequency signals, such as those required for serial absolute encoders, it is critical that shielded twisted pair cable be used all the way from the encoder to the controller. Even a 300 mm unshielded non-twisted pair cable from the controller to a bulkhead connector can result in significant signal corruption.

4. Hardware Reference

Guidance Controller Assemblies and Interfaces

The Guidance 1000A Controllers consist of two printed circuit board assemblies and a heat spreader mounting plate. These components are illustrated in [Figure 4-1](#).

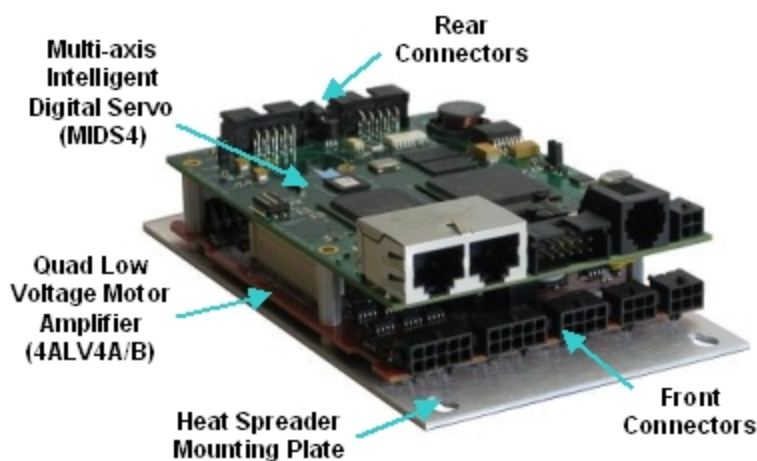



Figure 4-1: Guidance 1000A Controller Components

 DANGER Electrical Shock Hazard	
<p>Contact with electrical power can cause serious personal injury or death. Guidance 1000A controllers are powered by 24VDC and can contain voltages up to 48VDC to drive the motors.</p> <ul style="list-style-type: none">Mount these products in a cabinet or machine chassis that is not accessible when AC line power is on.	

The bottom electronic assembly is the Quad Low Voltage Motor Amplifier Board (4ALV4A) that contains 2, 3, or 4 motor drives. Mounted above it is the controller's high performance processor board - the Multi-axis Intelligent Digital Servo (MIDS4). All of the external interfaces are provided on the Front and Rear Connectors that are mounted on the leading and trailing edges of the MIDS4 and 4ALV4A boards. Each of these interfaces is described in detail later in this chapter. The bottom sheet metal mounting plate also serves to distribute the heat generated by the motor power modules. This plate must be mounted to a heat sink to conduct the amplifiers' heat away from the controller. In some systems, customers may wish to remove this plate and attach the controller directly to a metal frame or chassis. In this case, care must be taken to maintain the position of the thermal pad that conducts heat from the power devices on the Motor Amplifier Board to the mounting surface.

Connecting Power and Enabling Motor Power

The Guidance 1000A Controller, motor power supply, and 24VDC logic power supply should be connected as shown in [Figure 4-2](#). The 24V power supply is wired to a four pin [Motor Power On/24VDC Logic Power Connector](#) on the processor board. This connector provides power to the controller's high performance processor and the other logic circuits. The motor power supply is wired to either an 8-pin [Motor Power Input Connector on the 4ALV4A](#) or a ten pin [Motor Power Input Connector on the 4ALV4B](#) amplifier board. When enabled, this source provides power to the motors connected to the motor amplifiers. In [Figure 4-2](#), optional connections are indicated by dashed lines.

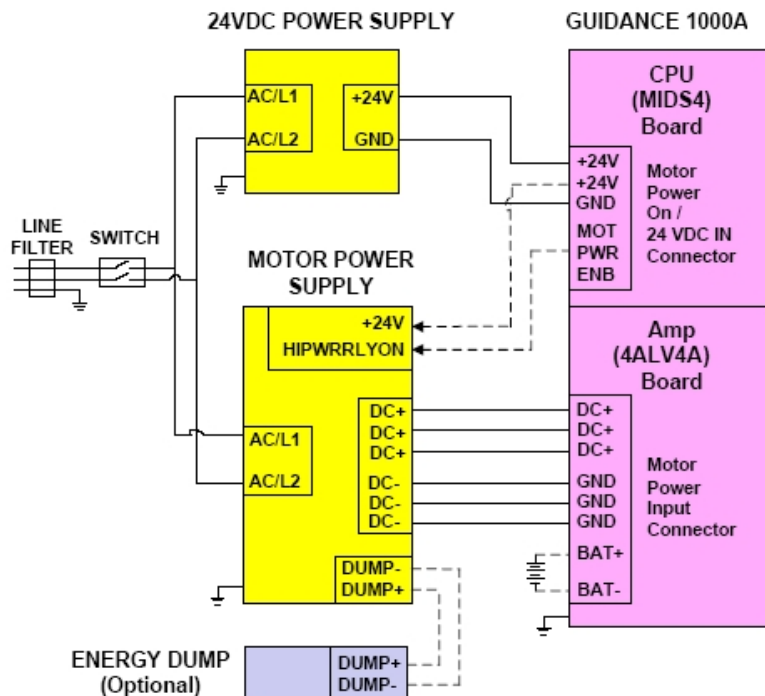



Figure 4-2: Guidance 1000A Controller, Motor Power Supply, and 24 VDC Logic Power Supply

 DANGER Electrical Shock Hazard	
Contact with electrical power can cause serious injury or death. The Guidance 1000A is powered by 24VDC and can contain voltages up to 48VDC to drive the motors. <ul style="list-style-type: none">Mount this product in a cabinet or machine chassis that is not accessible when AC line power is on.	

In order for the motors to be energized, the following conditions must all be satisfied:



- The motor power supply must be connected to the Motor Power Input Connector.
- The motor power supply must be outputting power.
- The controller must internally enable the amplifiers.



Since this controller only supports low motor voltages, there are several ways in which motor power can be safely supplied to the controller.

- The motor power supply output can be left powered on all of the time that the controller is being supplied with 24VDC logic power. Because the controller always internally enables and disables the power amplifiers as needed, the internal logic can safely control when power is provided to the motors.
- The Motor Power Enable signal from the [Motor Power On/24 VDC Logic Power Connector](#) can control a relay that turns the motor power supply on and off. Due to the low motor voltages, this is optional and is not required to meet safety regulations.
- The Motor Power Enable signal from the [Motor Power On/24 VDC Logic Power Connector](#) can be directly connected to an enable/disable input on the motor power supply. Due to the low motor voltages, this is optional and is not required to meet safety regulations.

Note that the G1400A provides three DC+ and three ground pins for connecting the motor power supply to the controller. This is required because the controller is able to output power to four motors simultaneously and the sum of the DC current required can exceed the current limit of a single pin. For the G1400A, each motor power pin is rated at up to 5A RMS. For higher power applications, it is necessary to wire all 3 DC and ground pins to allow enough current to flow to the power amplifiers without overheating the pins.

With regard to power supplies, even if the motors are energized by a 24VDC power supply, it is strongly recommended that the motor power supply be separate from the 24VDC logic power supply. When motors decelerate, they can regenerate significant power that flows back to the motor power supply. If the motor power supply is not designed to absorb this regenerated energy, the voltage of the motor supply can rise significantly. If this power supply is also connected to the controller's digital logic, the pumped up voltage will damage the controller.

 DANGER Electrical Shock Hazard	
<p>Contact with electrical power can cause serious personal injury or death.</p> <ul style="list-style-type: none">To avoid electrical shock, disconnect the power before troubleshooting the electrical components.	

 WARNING	
<p>If the voltage supplied to the controller's digital logic exceeds 26.4VDC, the controller's hardware will be damaged.</p> <p>Motor power supply voltage pump-up from decelerating motors can significantly exceed this limit. Do not connect the motor supply to the controller's logic unless the supply is specifically designed to absorb this energy and limit the voltage rise.</p>	 

Even though separate logic and motor power supplies are utilized, regenerated energy flowing back to the motor power supply may still cause problems. Unless the motor power supply is designed to absorb this energy, a significant voltage rise in the motor power supply may shut down this power supply or the controller may disable power to the motors to prevent the controller from being damaged. If a significant voltage rise is possible, an external Power Dump circuit should be added to the motor power supply.

In addition to the logic and motor power supplies, when certain types of absolute encoders are utilized, battery power must be supplied to the encoders when the controller is powered down in order for the encoders to retain their multiple turn counters. In this case, an external battery should be connected to pins on the Motor Power Input Connector. See ["Third Party Equipment: Overview" on page 52](#) for more information on absolute encoders and their battery requirements.

Controller Connectors

Controller Connectors: Overview

In addition to providing interfaces for up to four motors and encoders, the Guidance 1000A provide extensive communication services. The connectors for each of these interfaces are described in detail in this section. The list of the provided functionality is as follows:

- [Brake Release Connector](#)
- [Digital Input and Output Signals](#)
- [Encoder Interfaces](#)
- [Ethernet Interface](#)
- [Motor Interfaces](#)
- [Motor Interfaces \(G1000B Channels 1, 2, 4\)](#)
- [Motor Power/Encoder Battery Input Connector](#)
- [Motor Power/Encoder Battery Input Connector \(G1000B\)](#)
- [Motor Power On/24VDC IN](#)
- [Processor Board \(MIDS4\) Jumpers](#)
- [Remote Front Panel/Secondary RS-232 & RS-485 Port Connector](#)
- [Primary RS-232 Serial Interface](#)
- [RS-485 Serial Interface](#)
- [Status LED and Status Output Signal Connector](#)

To simplify mounting and cabling the controllers, all of the interfaces are provided on the Front and Back Connectors that are mounted on the leading and trailing edges of the controllers' PCBs.

[Figure 4-3](#) and [Figure 4-4](#) illustrate the interfaces that are provided by the G1000A Front and Back Connectors. To jump to the detailed information for a specific connector, click on the connector interface name or the connector in the following pictures.

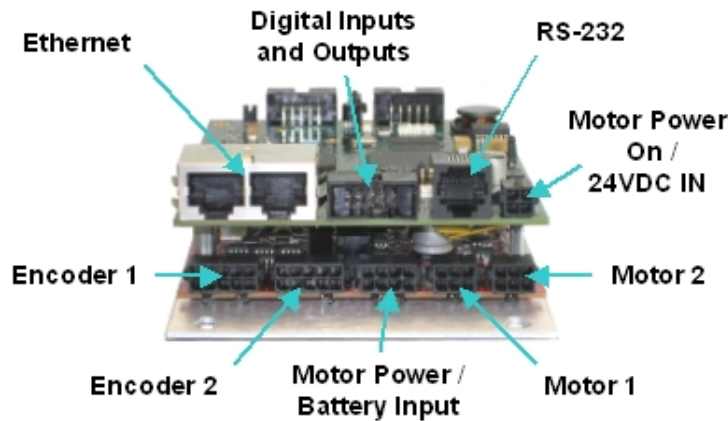

Figure 4-3: G1400A, Front Connectors

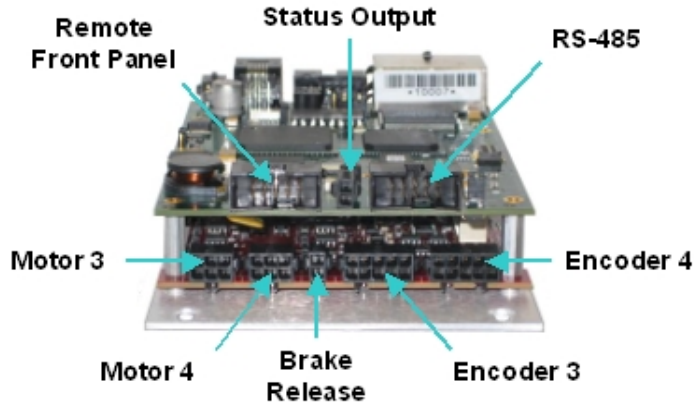

Figure 4-4: G1400A, Back Connectors

In the following sections, the pinouts for each of the connectors plus the part numbers for the mating plugs are presented.

Brake Release Connector

During normal operation, any brakes attached to motors are automatically released at the appropriate time to permit the axes to move. The Brake Release connector provides two pins that can be shorted together to force the brakes to be manually released. If desired, these signals are typically connected to a momentary contact manual brake release button. To simplify wiring, the control signals, BRAKE+ and BRAKE-, are present in each of the motor connectors. All of these signals are driven from the same source. The BRAKE+ signal is tied to 24VDC. When the brakes are not energized (released), the BRAKE- signal is permitted to float to 24VDC. To energize the brakes, the controller ties BRAKE- to ground. This connector exposes the BRAKE- and ground signals and permits the brakes to be released by externally tying BRAKE- to ground.

The Brake Release connector mounted on the motor drive board is a two-pin AMP 3-794618-2. The mating plug is an AMP 794617-2. See [Figure 4-5](#) and [Table 4-1](#).

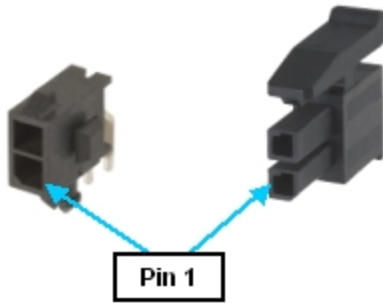

Figure 4-5: Two-pin AMP 3-794618-2 Connector and AMP 794617-2 Plug

Table 4-1: Pinout

Pin	Description
1	GND
2	BRAKE-. Connect this signal to GND to release the brakes.
User Plug Part No	AMP 794617-2. Use an AMP 91501-1 hand tool and AMP 794610-1 sockets for wiring to the plug.

Digital Input and Output Signals

The Guidance 1000A provides four general purpose optically isolated digital input signals and 4 general purpose optically isolated digital output signals. These signals are presented in a single 10-pin IDC connector ([Figure 4-6](#)). This type of connector permits these signals to be easily interfaced to other devices.

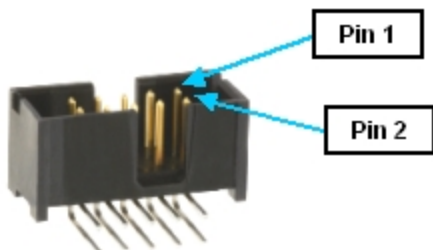

Figure 4-6: Ten-pin IDC Connector

By setting [Jumpers on the CPU \(MIDS4\)](#) board, the four output signals can be individually configured as "sinking" ([Figure 4-7](#) and [Figure 4-9](#)) or "sourcing" ([Figure 4-8](#) and [Figure 4-10](#)), and the four digital inputs can be configured as a group to all operate as either sinking or sourcing. If an input signal is configured as "sinking," the external equipment must provide a 5VDC to 24VDC voltage to indicate a logical high value or no voltage for a logical low. This configuration is compatible with "sourcing" (PNP) sensors.

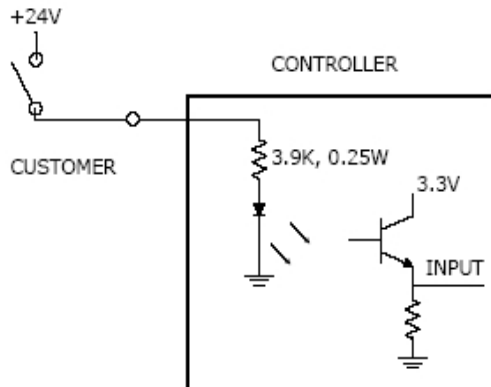

Figure 4-7: DIO Sinking Input

If an input signal is configured as "sourcing," the external equipment must pull the signal input pin to ground to indicate a logical high and must let the line float high to 24VDC to signal a logical low value. This configuration is compatible with "sinking" (NPN) sensors.

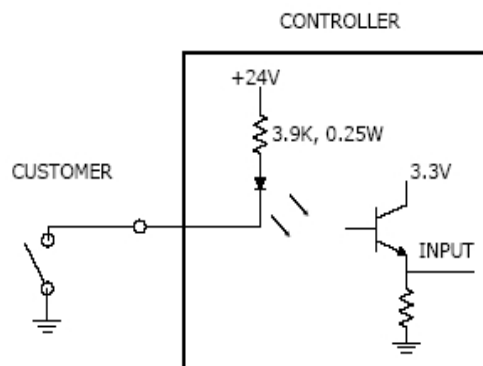

Figure 4-8: DIO Sourcing Input

If an output signal is "sinking," the external equipment must provide a 5VDC to 24VDC pull-up voltage on the output pin and the controller pulls this pin to ground when the signal is asserted as true. This configuration is compatible with "sourcing" (PNP) devices.

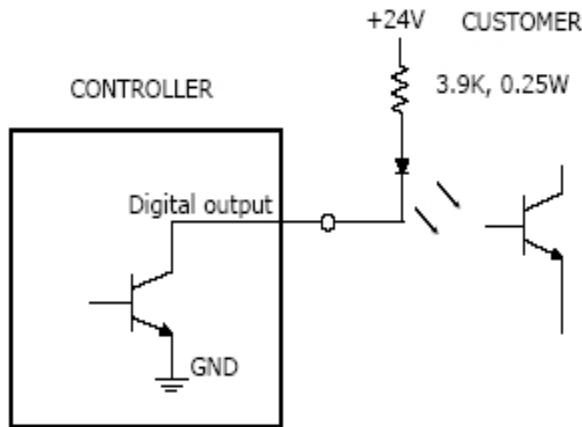

Figure 4-9: DIO Sinking Output

If an output signal is "sourcing," the external equipment must pull-down the output pin to ground and the controller pulls this pin to 24VDC when the signal is asserted as true. This configuration is compatible with "sinking" (NPN) devices.

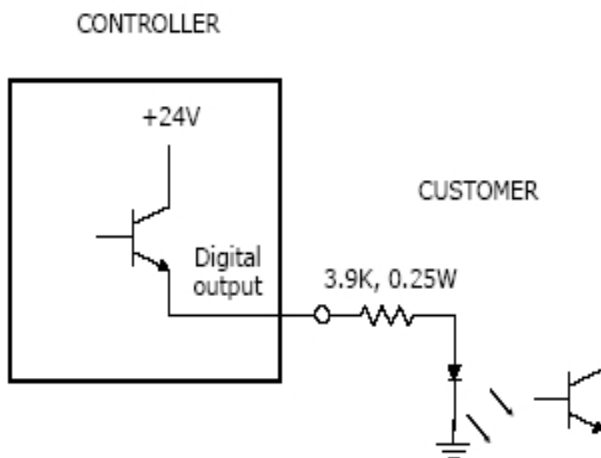

Figure 4-10: DIO Sourcing Output

NOTE: As shipped from the factory, standalone G1x00A controllers normally have all digital inputs configured as "sourcing" and all outputs configured as "sinking." For G1x00 controllers that are embedded within PreciseFlex Robots, consult the applicable robot manual for the default digital input and output sourcing and sinking settings.

The pinout for the Digital Input and Output Connector and the corresponding GPL signal numbers are described in [Table 4-2](#).

Table 4-2: Pinout and GPL Signal Numbers

Pin	GPL Signal Number	Description
1	13	Digital Output 1
2	14	Digital Output 2
3	15	Digital Output 3
4	16	Digital Output 4
5		GND
6		24VDC output
7	10001	Digital Input 1
8	10002	Digital Input 2
9	10003	Digital Input 3
10	10004	Digital Input 4
User Plug Part No		AMP 1658622-1 or Molex 22-55-2101 or 90142-0010. For the Molex plug, use Molex sockets 16-02-0103 or 90119-2110 and Molex crimp tool 63811-1000.

Encoder Interfaces

Guidance 1000A controllers are equipped with 2, 3, or 4 encoder interfaces that match the number of integrated motor drives. The signals for each of the encoder interfaces of the G1000A are provided in a 10-pin Amp 4-794620-0 connector that mates with an Amp 1-794617-0 plug (see [Figure 4-11](#)).

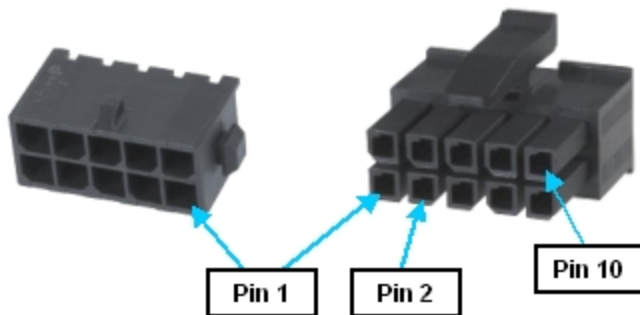

Figure 4-11: Ten-pin Amp 4-794620-0 Connector and Amp 1-794617-0 Plug

Each encoder interface can be configured for a differential or single-ended incremental encoder or a variety of absolute encoders. Since many absolute encoders require external battery backup power to retain the memory of their revolutions counters, each encoder interface includes a battery power line that is directly connected to the [Motor Power In Connector](#). See ["Third Party Equipment: Overview" on page 52](#) of this manual for more information on configuring and wiring absolute

encoders. Also, note that certain absolute encoders require the "Enhanced" version of the Guidance Controller due to special hardware requirements. Review the Installation section of this manual for recommendations on best practices for wiring encoders. Following the provided instructions will significantly reduce the likelihood of any problems due to noise in the encoder signals. The pinout for each Encoder Connector is described in [Table 4-3](#).

Table 4-3: Connector Pinouts

Pin	Description
1	GND
2	Encoder Z+
3	Encoder B-
4	Absolute encoder battery+ output
5	Encoder A+
6	Encoder Z-
7	GND
8	Encoder B+
9	Encoder A-
10	5VDC output provided to power encoders. The sum of the current drawn from all four encoder connectors is limited to 360 mA.
User Plug Part No	Amp 1-794617-0. Use an AMP 91501-1 hand tool and AMP 1-794610-2 sockets for wiring to the plug.

Ethernet Interface

The controller includes an Ethernet switch that implements two 10/100 Mbit Ethernet ports. This capability was designed to permit the controller to be interfaced to devices such as other PreciseFlex™ controllers, remote I/O units, and Ethernet cameras. The Ethernet switch automatically detects the sense of each connection, so either straight-through or cross-over cables can be used to connect the controller to any other Ethernet device. See [Figure 4-12](#).



Figure 4-12: Ethernet Connector and Cable

Either Ethernet port can be used to interface to the Guidance controller. If the two ports are connected to external equipment that are communicating with each other but not the controller, the switch automatically routes the traffic between the two ports and does not send this information to the controller. For example, if an Ethernet camera is connected to one port and a PC is connected to the other port, the camera image data will not burden the controller's CPU. See the *Setup and Operation Quick Start Guide* for instructions on setting the IP address for the controller.

Motor Interfaces

Guidance 1000A controllers are equipped with 2, 3, or 4 motor drives. The motor interface for each drive of the G1000A is provided in a 6-pin AMP 3-794618-6 connector that mates with a AMP 794617-6 plug. See [Figure 4-13](#).

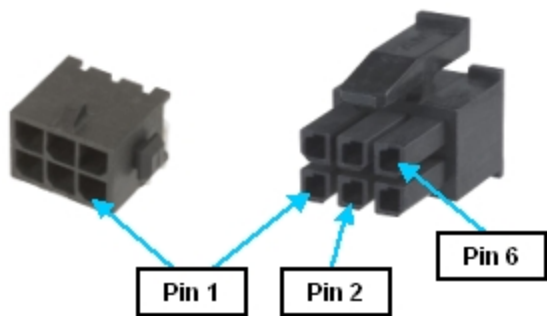

Figure 4-13: Six-pin AMP 3-794618-6 Connector and AMP 794617-6 Plug.

As a wiring convenience, each of the motor connectors includes brake control signals for energizing (releasing) a brake. Internally, all of these brake signals are controlled by the same logic, so all brakes are released together rather than on an individual basis. If individual brake control is required, the general purpose digital output lines can be configured for this function. The system also includes an input for manually releasing the brakes (see the [Brake Release Connector](#)). Review the Installation section of this manual for recommendations on best practices for wiring motors. Following the provided instructions will significantly reduce the likelihood of the motors generating undesirable electrical noise. The pinout for the Motor Connector is described in [Table 4-4](#).

Table 4-4: Connector Pinout

Pin	Description
1	Brake power output, 24VDC, maximum current 2 A total for all brakes
2	Motor phase V
3	Motor phase W
4	Brake power return. Set to ground to energize (release) brakes otherwise 24VDC.

Pin	Description
5	Motor frame ground/cable shield
6	Motor phase U
User Plug Part No	AMP 794617-6. Use an AMP 91501-1 hand tool and AMP 794610-1 sockets for wiring to the plug.

Motor Power/Encoder Battery Input Connector

The power to drive the motors must be supplied separately from the logic power. The logic power must be 24VDC and must be continuously on while the controller is operational. The motor power can range from 12VDC to 48VDC and may be turned on and off whenever the robot is enabled or disabled. The power to drive the motors and any required battery backup power needed for absolute encoders is supplied via the Motor Power Input Connector. For the G1000A, this connector is an 8-pin AMP 3-794618-8 that mates with an AMP 794617-8 plug. See [Figure 4-14](#).

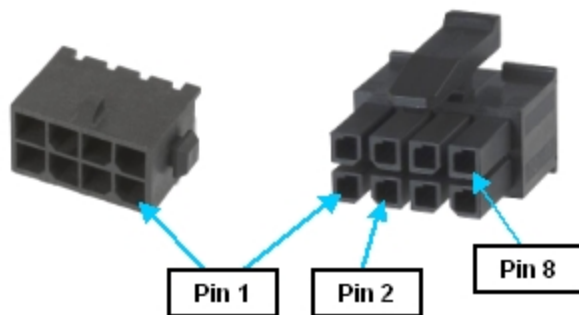

Figure 4-14: Eight-Pin AMP 3-794618-8 Connector and AMP 794617-8 Plug

See [Connecting Power and Enabling Motor Power](#) for general information concerning enabling motor power.

Since many absolute encoders require external battery backup power to retain the memory of their revolutions counters, this connector provides a means for connecting a battery to the system. Any battery power provided on these pins is directly routed to each of the [Encoder Interface Connectors](#). See ["Third Party Equipment: Overview" on page 52](#) for more information on configuring and wiring absolute encoders. Also, note that certain absolute encoders require the "Enhanced" version of the Guidance Controller due to special hardware requirements.

NOTE: Due to the low voltage of batteries and the very low current drain of encoders in standby mode, a poor or higher resistance connection between the battery and the encoder can result in a momentary loss of power to the encoder. Even a very short loss of power can result in an absolute encoder losing its calibration data and signaling a low battery voltage error. So, all connectors from the battery, through the

controller and out to the encoder must be gold plated with high compression forces and all wires must have very low resistance.

The pinout for the G1000A Motor Power Input Connector is described in [Table 4-5](#).

Table 4-5: Connector Pinout

Pin	Description
1	Motor power input, 12VDC to 48VDC nominal. Three pins are provided for higher power/motor current systems to ensure that the current ratings of the pins/power cables are not exceeded.
2	
3	
4	Absolute encoder battery+ input
5	GND. Three pins are provided for higher power/motor current systems to ensure that the current ratings of the pins/power cables are not exceeded.
6	
7	
8	Absolute encoder battery- input
User Plug Part No	AMP 794617-8. Use an AMP 91501-1 hand tool and AMP 794610-1 sockets for wiring to the plug.

Motor Power On/24VDC IN

This is a 4-pin AMP 3-794620-4 connector that: (1) outputs a signal that controls turning on and off an external motor power supply and (2) provides the 24VDC that powers the digital section of the controller. The mating plug is an AMP 794617-4. See [Figure 4-15](#).

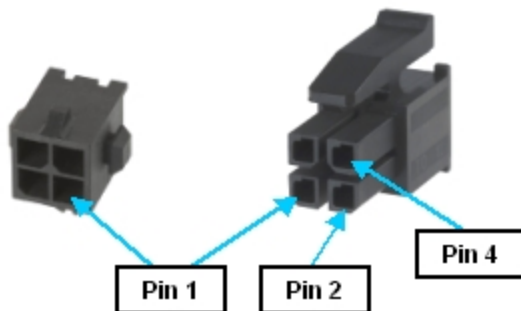

Figure 4-15: Four-pin AMP 3-794620-4 Connector and AMP 794617-4 Plug

To operate high voltage motors, such as those driven by the Guidance 3000/2000 series controllers, the motor bus voltage must be enabled and disabled by relays that connect/disconnect the motor power supply from the AC line voltage.

In the case of the Guidance 1000A controllers, the Motor Power On connector provides a signal that switches to ground when motor power is enabled and is automatically opened when an E-Stop or other condition occurs that requires the motors to be disabled.

This signal can be connected to a motor power supply relay or directly to an off-the-shelf power supply. However, in all applications of the G1000A (which by design are limited to low voltage and low power), the motor power supply can be continuously enabled and the Guidance controller can internally turn on and off the power to the motors as necessary.

For these configurations, the motor power enable/disable signal provided in this connector is not used. The 24VDC power input and ground pins on this interface should be connected to a low voltage power supply that remains on independently of whether the motors are enabled. All of the controller's logic functions, the digital input and output signals and the other communication interfaces are supplied by this power source.

As soon as this power is provided, the system begins its booting process. Turning off the 24VDC will completely shutdown the controller. As a wiring convenience, the 24VDC input power is internally looped back to a 24VDC output power pin that can supply logic power to an external motor power supply. The pin designations for the mating plug to this connector are denoted in [Table 4-6](#).

Table 4-6: Pins & Plug

Pin	Description
1	+24VDC input
2	+24VDC output
3	GND
4	Motor power enable. Switched to ground when power is being enabled otherwise opened. Capable of sinking 2A at 24VDC.
User Plug Part No	AMP 794617-4. Use an AMP 91501-1 hand tool and AMP 794610-1 sockets for wiring to the plug.

Processor Board (MIDS4) Jumpers

The high performance processor board (MIDS4) has a number of hardware jumpers that determine the configuration of some basic system hardware and software functions. Depending upon the jumper type, there may be two, three, or five posts. Posts are tied (shorted) together using black jumper plugs. The five wide jumper posts for configuring the digital output signals are shown in [Figure 4-16](#).



Figure 4-16: Five Jumper Posts

The locations of each of the sets of jumpers of interest are illustrated in [Figure 4-17](#) and are identified by stenciled labels on the surface of the MIDS4 board.

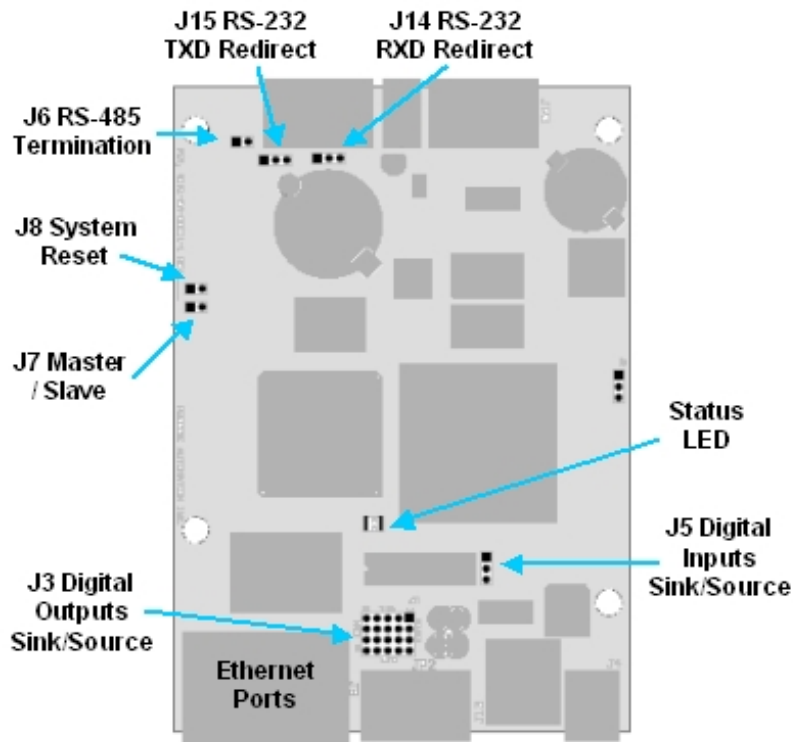

Figure 4-17: Jumper Locations

[Table 4-7](#) describes each of the sets of jumpers and how the pins must be shorted ("jumped") in order to set a specific configuration. When a direction (e.g. left versus right) is described, it is with respect to the MIDS4 board oriented as shown in [Figure 4-17](#).

Table 4-7: Jumpers & Pins

Jumpers	Description	Setting
J14/J15 RS-232 Redirect	Normally, jumpers are installed between posts 1 and 2 (the left-most) of J14 and J15 to permit COM1 to be accessed via the standard RS-232 RJ-11 modular jack . However, if jumpers are installed between posts 2 and 3 of J14 and J15, the transmit and receive signals of the COM1 RS-232 serial communications port are redirected to pins in the RS-485 connector . This feature was added to permit the PreciseFlex 400 robot to support a serial bar code reader mounted on the robot's gripper. As shipped from the factory, jumpers are provided across pins 1&2 to configure normal RS-232 operation via the RJ-11 connector.	For COM1 operation via the RJ-11, J14-1 TO J14-2 J15-1 TO J15-2 For COM1 operation via the RS-485 connector, J14-2 TO J14-3 J15-2 TO J15-3
J8 System Reset	If a jumper is installed on these two posts, when the system is restarted, the default configuration files (*.PAC) are applied instead of the standard files. This setting is utilized if a configuration file becomes corrupted or a setting inadvertently makes the system unusable. As shipped from the factory, this jumper is not installed. NOTE: In newer boards, J8 has three posts instead of two. For these units, pins 1 & 2 should be shorted to reset the system.	Install jumper J8 to reset the system or short pins 1 & 2 in newer boards.
J7 Master / Slave	This jumper determines if the controller operates in Master or Slave node in a multiple controller servo network. If the controller operates by itself, it should be set in Master mode. As shipped from the factory, this jumper is not installed and indicates Master mode. NOTE: In newer boards, J7 has three posts instead of two. For these units, pins 1 & 2 should be shorted to set slave mode.	Install jumper J7 to select Slave mode or short pins 1 & 2 in newer boards.
J6 RS-485 Termination	This jumper controls how the RS-485 serial communication lines are terminated. For reliable communications, if the controller is at the end of a RS-485 daisy chain, this jumper should be installed to terminate the line. If the controller is in the middle of a RS-485 daisy chain, this jumper must be uninstalled to disable the termination. As shipped from the factory, this jumper is installed and the RS-485 lines are terminated.	Install jumper J6 to terminate the RS-485 communication lines.
J5 Digital Inputs Sink/Source	These jumpers determine if all four of the General Purpose Digital Input Signals are "sinking" or "sourcing." There is just one set of three posts and their setting dictates the behavior of all four inputs. Pin 1 is to the top-most post and pin 3 is to the bottom-most. As shipped from the factory, the inputs are set to sourcing.	For Sinking, J5-3 TO J5-2 For Sourcing, J5-2 TO J5-1
J3 Digital Outputs Sink/Source	These jumpers determine if each of the General Purpose Digital Output Signals is "sinking" or "sourcing." These jumpers consist of four rows of five posts. Each row determines the setting for a single digital output. The top row corresponds to the first digital output signal. Two jumpers must be set in each row. Within each row, pin 1 is the right-most post and pin 5 is the left-most. As shipped from the factory, the outputs are set to sinking.	For Sinking, J3-5 TO J3-4 J3-3 TO J3-2 For Sourcing, J3-4 TO J3-3 J3-2 TO J3-1
Status LED	This is a green LED that blinks to indicate the operational status of the controller.	

Remote Front Panel/Secondary RS-232 & RS-485 Port Connector

The remote front panel interface includes a RS-232 serial port for connecting to a Manual Control Pendant (MCP) and redundant E-Stop inputs for receiving hardware E-Stop signals. This interface provides the functionality necessary to implement a remote front panel that is appropriate for a low-voltage, low-power control system. As a wiring convenience, this interface also includes duplicates of the RS-485 signals that are provided on the [RS-485 Serial Interface](#) connector. All of these signals are presented in a ten-pin IDC connector (Figure 4-18).

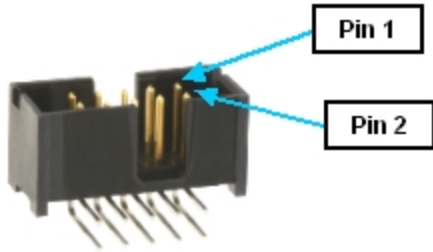

Figure 4-18: Ten-pin IDC Connector

If a Manual Control Pendant is not connected to the RS-232 port, this serial interface can be accessed via a GPL procedure as device `/dev/com2` for general communications purposes. Unlike the primary RS-232 port, this serial port does not include hardware flow control.

If a remote front panel, MCP with E-Stop or a E-Stop button is not interfaced to this connector, the following pins on the front panel connector must be jumpered in order for the controller to operate properly. (The controller is shipped with these jumpers installed.)

1-2, 3-4

The pinout for the Remote Front Panel Connector is described in [Table 4-8](#).

Table 4-8: Pinout

Pin	Description
1	ESTOP_L 1 (If no front panel or E-Stop not asserted, connect to pin 2). An input signal that is low or open indicates that a hardware E-Stop condition has been asserted by some source. Set high if no E-Stop condition is asserted. The controller hardware will not permit motor power to be enabled when an E-Stop condition exists.
2	Force ESTOP_L 1. Output signal that, when low, indicates that the Remote Front Panel should force ESTOP_L 1 to be asserted (low). The System Software toggles this signal low at start-up to verify that the ESTOP_L 1 is properly working. The System Software also uses this as a means for asserting a hardware E-Stop condition during normal operation. This signal is normally held high.
3	ESTOP_L 2 (If no front panel or E-Stop not asserted, connect to pin 4). Redundant ESTOP input signal.
4	Force ESTOP_L 2. Redundant Force ESTOP output signal.

Pin	Description
5	MCP RS-232 RXD - controller receives data.
6	MCP RS-232 TXD - controller transmits data
7	24VDC output
8	GND
9	RS485+. This is a duplicate of the signal provided in the RS-485 interface connector.
10	RS485-. This is a duplicate of the signal provided in the RS-485 interface connector.
User Plug Part No	AMP 1658622-1 or Molex 22-55-2101 or 90142-0010. For the Molex plug, use Molex sockets 16-02-0103 or 90119-2110 and Molex crimp tool 63811-1000.

Primary RS-232 Serial Interface

The primary RS-232 serial communication line connector is a RJ-11 modular jack, Tyco 5555165-1. The plug is a standard RJ-11 phone plug, such as an Jameco 115617CH. This port is used as the serial console port and can also be accessed by GPL procedures as device /dev/com1.

As a special feature, if [jumpers are moved](#) on the CPU (MIDS4) board, the primary RS-232 serial port's transmit and receive signals can be accessed via the [RS-485 connector](#) instead of the RJ-11 jack. This option was developed to permit the PreciseFlex 400 robot to support a bar code reader that is mounted on the robot's gripper. See [Figure 4-19](#) and [Table 4-9](#).



Figure 4-19: RS-232 and Cable

Table 4-9: Pinout

Pin	Description
1	CTS - clear to send
2	RTS - ready to receive

Pin	Description
3	Ground
4	RXD - controller receive data
5	TXD - controller transmit data
6	Ground
User Plug Part No	RJ-11 phone plug

RS-485 Serial Interface

RS-485 is a multi-drop serial communication interface. At the application level, it can transmit and receive data in a manner similar to a RS-232 interface with the added benefit that the communication lines can be daisy chained between multiple nodes instead of requiring point-to-point wiring. Within GPL application programs, this port is referenced as "/dev/com4."

For reliable communications, RS-485 lines must be terminated at both ends of the daisy chain and must not have any termination at interior nodes. The RS-485 termination is controlled by a [jumper on the CPU \(MIDS4\)](#) board. By default, this jumper is installed and the line is terminated.

The RS-485 interface is not available for interfacing to 3rd party devices when the controller is embedded in a Preciseflex robot such as the Preciseflex 400. In this robot, this interface is dedicated to communicating with other boards, such as the GSB and GIO, that may be built into the robot.

As a special feature, if [jumpers are moved](#) on the CPU (MIDS4) board, the controller's primary serial port (COM1) transmit and receive signals can be accessed via this RS-485 connector instead of the standard [RJ-11 modular jack](#). This option was developed to permit the Preciseflex 400 robot to support a bar code reader that is mounted on the robot's gripper.

This interface is provided in a ten-pin IDC connector. See [Figure 4-20](#) and [Table 4-10](#).

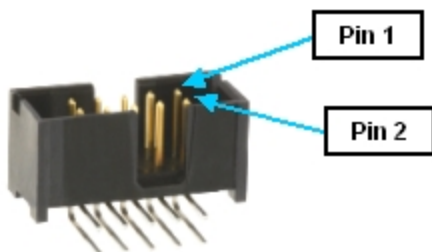

Figure 4-20: Ten-Pin IDC Connector

Table 4-10: Pinout

Pin	Description
1	24VDC. Starting in early 2013, all Guidance Controllers can output a maximum of 2A at 24VDC on the RS-485 connector assuming that the controller's 24VDC power supply has sufficient power. Prior to early 2013, this was limited to only 1.35A.
2	
3	Floating or COM1 RXD signal if jumper J14 has posts 2 & 3 connected.
4	Floating or COM1 TXD signal if jumper J15 has posts 2 & 3 connected.
5	GND
6	VCC
7	GND
8	RS485+
9	RS485-
10	GND
User Plug Part No	AMP 1658622-1 or Molex 22-55-2101 or 90142-0010. For the Molex plug, use Molex sockets 16-02-0103 or 90119-2110 and Molex crimp tool 63811-1000.

Status LED and Status Output Signal Connector

The MIDS4 board includes a Status LED and a Status Digital Output Signal that indicate the execution state of the controller. The execution conditions that are displayed by the LED and the output signal (if configured) are described in the [Status LED and Status Output Signal](#) section.

The redundant Status Digital Output Signal permits an external LED to be driven if the controller is embedded and the on-board LED is not visible. This digital output is an extra signal and is not one of the four [General Digital Output Signals](#). If an external LED is not required, this output signal can be utilized as an extra general digital output.

This additional digital output signal is provided via a two-pin AMP 3-794620-2 connector. The mating plug is an AMP 794617-2. See [Figure 4-21](#).

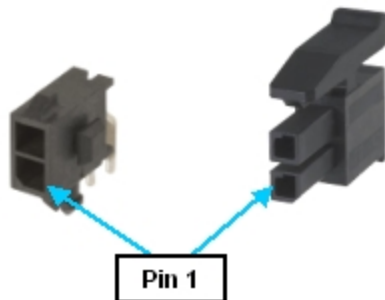

Figure 4-21: Two-pin AMP 3-794620-2 Connector and AMP 794617-2 Plug

This digital output signal always operates as "sourcing" (Figure 4-22) in order to drive an external LED.

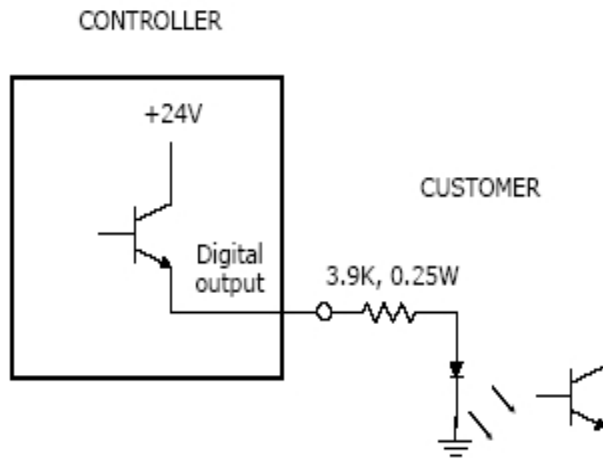

Figure 4-22: DIO Sourcing Output

To configure this digital output signal to blink in synchronization with the Status LED, the "Power State DOUT" (DataID 235) value in the controller's Parameter Database should be set to "20" (the digital output's signal number). See Table 4-11.

Table 4-11: Pinout

Pin	GPL Signal Number	Description
1	20	Digital Output 8
2		GND
User Plug Part No		AMP 794617-2. Use an AMP 91501-1 hand tool and AMP 794610-1 sockets for wiring to the plug.

Low-Voltage Power Supply and G1000A Controllers

The Guidance G1000A Controllers require a minimum of 2 amps and preferably 4 Amps of 24VDC power for the logic and IO. A commercially available 24VDC power supply, the Mean Well P/N PPS-125-24, is shown in [Figure 4-23](#) and [Table 4-12](#). This is a frameless supply that should be mounted on 4 mm high standoffs. Mounting holes are 4 mm diameter and will clear 3 mm or 6-32 screws. They are located on 64.8 mm and 115.6 mm centers. The AC input connector is a JST VHR-3N and the DC output connector is a JST VHR-8N. Pins 1-4 on the DC connector are GROUND and pins 5-8 are 24VDC. For the JST VHR connectors, use pins SVH-21T-1.1 and JST crimp tool WC-160.

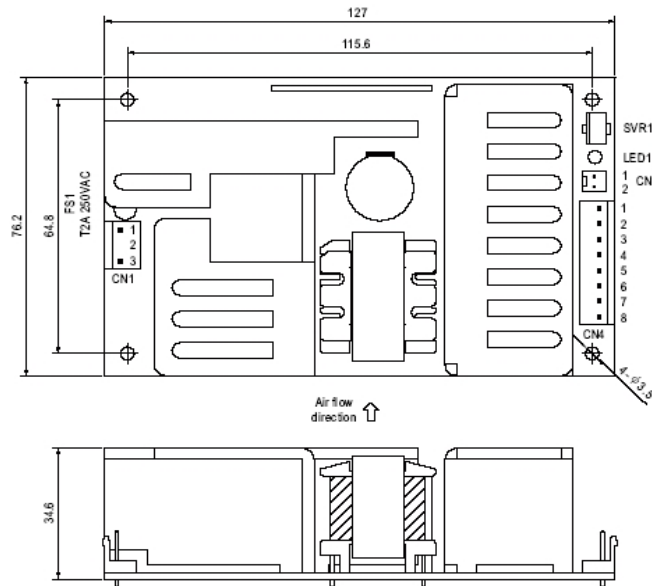



Figure 4-23: 24VDC Mean Well P/N PPS-125-24 Power Supply

Table 4-12: Power & Range

General Specification	Range
Input voltage	90 - 264 VAC
Input frequency	47 - 63 Hz
Output voltage	24VDC
Output power	125 Watts
Operating temperature	0 - 40° C
Storage temperature	-20 - 85° C
Dimensions	127 x 76.2 x 34.6 mm
PreciseFlex Part Number	PS10-EP-00125

 DANGER Electrical Shock Hazard	
<p>Contact with electrical power can cause serious personal injury or death. The Mean Well 24VDC power supply is an open frame electrical device that contains unshielded high voltage pins, components and surfaces.</p> <ul style="list-style-type: none">• Mount this product in a cabinet or machine chassis that is not accessible when AC line power is turned on.	

5. Third Party Equipment

Third Party Equipment: Overview

This section contains instructions on interfacing to 3rd party equipment that is commonly utilized in combination with the Guidance Controllers. For detailed information on each of these products, refer to the manuals provided by the manufactures of these components.

Panasonic A4 Serial Incremental/Absolute Encoder

This section provides wiring instructions for a Panasonic motor equipped with a Panasonic A4 17-bit serial incremental/absolute encoder or a 10000 count serial incremental encoder. These encoders transmit their position data as a serial bit stream via RS-485 lines rather than A-B incremental pulses. These encoders can be utilized as high resolution incremental encoders that provide either 17-bits or 10000 counts per revolution. In addition, if the 17-bit encoder is provided with continuous power with a battery backup, it functions as a high resolution absolute encoder that provides 33-bits of encoder position information. The continuous power is used to maintain a 16-bit "turns count" register that augments the 17-bits per turn data.

Due to the additional capabilities needed to process the absolute encoder signal, these encoders may require the "Enhanced" versions of the Guidance Controllers. Contact Brooks at support@preciseflex@brooksautomation.com for the current hardware requirements for interfacing to these types of encoders.

For information on configuring this type of encoder, see the *Software Setup* section of the *Controller Software* section of the *PreciseFlex Library*.

In addition to the Encoder Connections in [Table 5-1](#), review the [Installation Information](#) for important recommendations on the use of twisted pair wires and shield grounding.

Table 5-1: Encoder Connections

Encoder Connector Pin	Wire Color	Signal Name	G1000A Connector Pin
1	RED	BATTERY+	4
2	PINK	BATTERY -	7

Encoder Connector Pin	Wire Color	Signal Name	G1000A Connector Pin
3	GREEN	FG	
4	BLUE	PS+	5
5	VIOLET	PS-	9
6	NC	NC	
7	WHITE	VCC	10
8	BLACK	GND	7
9	NC	NC	

[Table 5-2](#) denotes the wiring instructions for the Motor Power Connectors.

Table 5-2: Wiring Instructions for Motor Power Connectors

Motor Connector Pin	Wire Color	Signal Name	G1000A Connector Pin
1	RED	U	6
2	WHITE	V	2
3	BLACK	W	3
4	GREEN	GND	5
1	YELLOW	BRAKE+	1
2	YELLOW	BRAKE-	4

If the encoder is to be used in absolute mode, a battery must be connected to the [Motor Power Input Connector](#). See the information on that connector for detailed pinouts and plug types. [Table 5-3](#) contains information on the required battery power.

Table 5-3: Required Battery Power

External Battery Specification	
Maximum voltage	4.75V
Typical voltage	3.6V
Alarm trigger voltage	3.1V
Current for each encoder	3.6 uA

Tamagawa Serial Incremental/Absolute Encoder

This section provides wiring instructions for a motor equipped with a Tamagawa SA35-17/33Bit-LPS (TS5667N120/N127) absolute encoder. This encoder transmits its position data as a serial bit stream via RS-485 lines rather than A-B incremental pulses. This encoder can be utilized as high resolution incremental encoder that provides 17-bits of resolution per revolution. In addition, if this encoder is provided with continuous power with a battery backup, it functions as a high resolution absolute encoder that provides 33-bits of encoder position information. The continuous power maintains a 16-bit "turns count" register that augments the 17-bits per turn data.

Due to the additional capabilities needed to process the absolute encoder signal, these encoders may require the "Enhanced" versions of the Guidance Controllers. Contact Brooks at support.preciseflex@brooksautomation.com for the current hardware requirements for interfacing to these types of encoders.

For information on configuring this type of encoder, see the *Software Setup* section of the *Controller Software* section of the *PreciseFlex Library*.

In addition to the Encoder Connections in [Table 5-4](#), review the [Installation Information](#) for important recommendations on the use of twisted pair wires and shield grounding.

Table 5-4: Encoder Connections

Tamagawa Motor Pin	Wire Color	Signal Name	G1000A Connector Pin
A4	BROWN	BATTERY+	4
B4	BROWN/BLACK	BATTERY -	7
B6	GRAY	FG	1
A3	BLUE	PS+	5
B3	BLUE/BLACK	PS-	9
A5	RED	VCC	10
B5	BLACK	GND	7

If the encoder is to be used in absolute mode, a battery must be connected to the [Motor Power Input Connector](#). See the information on that connector for detailed pinouts and plug types. [Table 5-5](#) contains information on the required battery power.

Table 5-5: Required Battery Power

External Battery Specification	
Maximum voltage	4.75V
Typical voltage	3.6V
Alarm trigger voltage	3.1V
Current for each encoder	3.6 uA

Yaskawa Sigma II/III Serial Absolute Encoder

This section provides wiring instructions for a Yaskawa motor equipped with a Yaskawa Sigma II/III Serial Absolute Encoder. The encoder can have 16-bits (Sigma II), 17-bits (Sigma II/III) or 20-bits (Sigma II/III) of resolution per revolution plus a battery backed-up multiple turns counter. This encoder transmits its position as a serial bit stream via RS-485 lines instead of A-B incremental pulses.

Due to the additional capabilities needed to process the absolute encoder signal, these encoders may require the "Enhanced" versions of the Guidance Controllers. Contact Brooks at support_preciseflex@brooksautomation.com for the current hardware requirements for interfacing to these types of encoders.

For information on configuring this type of encoder, see the *Software Setup* section of the *Controller Software* section of the *PreciseFlex Library*.

In addition to the encoder connections in [Table 5-6](#), review the [Installation Information](#) for important recommendations on the use of twisted pair wires and shield grounding.

Table 5-6: Encoder Connections

Encoder Connector Pin	Wire Color	Signal Name	G1000A Connector Pin
1	RED	5V	10
2	BLACK	GND	1
3	ORANGE	BATTERY +	4
4	WHITE/ORANGE	BATTERY -	7
5	LIGHT BLUE	DATA+	5
6	WHITE/LIGHT BLUE	DATA -	9

Table 5-7 denotes the wiring instructions for the Motor Power Connectors.

Table 5-7: Motor Power Connectors

Motor Connector Pin	Wire Color	Signal Name	G1000A Connector Pin
1	RED	U	6
2	WHITE	V	2
3	BLUE	W	3
4	GREEN/YELLOW	FG	5
1	RED	BRAKE+	1
2	BLACK	BRAKE-	4

For the multi-turn counter to operate properly, a battery must be connected to the [Motor Power Input Connector](#). See the information on that connector for detailed pinouts and plug types. [Table 5-8](#) contains information on the required battery power.

NOTE: Unlike other absolute encoders, the Sigma II/III does not have an internal battery or capacitor that can retain the multi-turn data. Therefore, if the external battery is disconnected while the controller's power is off or the cable from the controller to the encoder is disconnected at anytime, the multi-turn data will be lost and the absolute position of the motor and encoder will have to be reestablished.

Table 5-8: Required Battery Power

External Battery Specification	
Typical voltage	3.6V
Alarm trigger voltage	2.7V
Current for each encoder	20 uA

Nikon A / Sanyo Denki Serial Absolute Encoders

This section provides wiring instructions for a motor equipped with a Nikon A 2.5 Mhz, a Nikon A 4 Mhz, or a Sanyo Denki PA035C 2.5 Mhz serial absolute encoder. These encoders transmit their position data using a specialized serial bit stream protocol via a RS-485 pair rather than A-B incremental quadrature pulses. When these encoders are provided with a battery backup source, they function as a high resolution absolute encoder that returns 17-bits of resolution per revolution and a 16-bit "turns count" battery backed-up register for a total of 33-bits of encoder position information.

Due to the additional capabilities needed to process the absolute encoder signal, these encoders may require the "Enhanced" versions of the Guidance Controllers. Contact Brooks at support_preciseflex@brooksautomation.com for the current hardware requirements for interfacing to these types of encoders.

For information on configuring this type of encoder, see the *Software Setup* section of the *Controller Software* section of the *PreciseFlex Library*.

In addition to the encoder connections in [Table 5-9](#), review the [Installation Information](#) for important recommendations on the use of twisted pair wires and shield grounding.

Table 5-9: Encoder Connections

Wire Color	Signal Name	G1000A Connector Pin
BROWN	ES +	5
BLUE	ES -	9
RED	5V	10
BLACK	GND	7
PINK	EBAT +	4
PURPLE	EBAT -	7

For the multi-turn counter to operate properly, a battery must be connected to the [Motor Power Input Connector](#). See the information on that connector for detailed pinouts and plug types. [Table 5-10](#) contains information on the required battery power.

NOTE: If the external battery is disconnected while the controller's power is off or the cable from the controller to the encoder is disconnected at anytime, the multi-turn data may be lost and the absolute position of the motor and encoder will have to be reestablished.

Table 5-10: Required Battery Power

External Battery Specification	
Typical voltage	3.6V
Alarm trigger voltage	3.0V

EnDat / SII / BiSS Serial Absolute Encoders

This section provides wiring instructions for motors equipped with one of the following types of serial absolute encoders:

- Heidenhain EQN1135, EnDat 2.2, 23-bits/revolution, 12-bit multiple turns counter
- Heidenhain EQI1130, EnDat 2.1, 18-bits/revolution, 12-bit multiple turns counter
- SSI with 24-bit position counter
- BiSS with 26-bit or 32-bit position counter

These encoders transmit their position data using different specialized serial bit stream protocols (via a RS-485 pair) rather than A-B incremental quadrature pulses. Unlike other absolute encoders, these devices also require a second RS-485 pair to transmit a data clocking signal from the controller to the encoder. In general, these encoder types do not require a battery backup source to maintain their multiple turns counter.

Due to the additional capabilities needed to process the absolute encoder signal, these encoders may require the "Enhanced" versions of the Guidance Controllers. Contact Brooks at support_preciseflex@brooksautomation.com for the current hardware requirements for interfacing to these types of encoders.

For information on configuring these types of encoder, see the *Software Setup* section of the *Controller Software* section of the *PreciseFlex Library*.

In addition to the encoder connections in [Table 5-11](#), review the [Installation Information](#) for important recommendations on the use of twisted pair wires and shield grounding.

Table 5-11: Encoder Connections

Signal Name	G1000A Connector Pin
DATA +	5
DATA -	9
5V	10
GND	7
CLOCK +	8
CLOCK -	3

Appendices

Appendix A: Product Specifications

Guidance 1000A Controller Specifications

Table 5-12: Guidance 1000A Controller Specifications

General Specification	Range & Features
Computational Hardware	
CPU and Dynamic Memory	400 Mhz high performance, low-power CPU with 16 MB or 32 MB of dynamic RAM
Nonvolatile Memory	Flash disk with 16 MB or 32 MB of storage for OS, firmware and user program and data storage
NVRAM	8 KBytes of NVRAM for storing key dynamic status and state information including error logs (available on controllers shipped starting in 2013 Q3)
Software	
Programming Interface	Three programming methods available: <ul style="list-style-type: none"> • DIO MotionBlocks (PLC) • Embedded Guidance Programming Language (GPL) • PC/Unix/Linux controlled over Ethernet
Operator Interface	Web-based operator interface supports local or remote control via browser connected to embedded web server

General Specification	Range & Features
<p>Motion Control</p> <p>Optional: Machine Vision</p>	<p>Extensive robotic and low-level motion control available:</p> <ul style="list-style-type: none"> • Continuous path following, s-curve profiling • Straight-line and circular motions • Torque and velocity control • Control of up to 32 axes via networked distributed control organized into up to 12 multi-axis robots • Distributed control network can consist of up to 16 controllers <p>Available upgrades:</p> <ul style="list-style-type: none"> • Optional conveyor belt tracking capability • Optional kinematic models for various robot geometries • Optional Advanced Controls License - Enables enhanced motion control modes including: high speed position latching, real-time trajectory modification, analog output controlled by robot speed, and support for EtherNet/IP <p>Provides controller with a complete set of image-processing, measurement, inspection and finder tools. A powerful patented Object Locator finds parts in any orientation and at different scales within milliseconds.</p>
<p>Motion Control</p>	
<p>Motor Drives</p>	<p>For the G1000A, up to four integrated motor drives:</p> <ul style="list-style-type: none"> • Drives 1 & 2:16.5A peak/6A RMS/6A stall per channel • Drives 3 & 4:10.3A peak/6A RMS/6A stall per channel <p>Bus voltage & total power for all drives:</p> <ul style="list-style-type: none"> • 12VDC to 48VDC • 720W @ 48VDC, 180W @ 12VDC total with proper heat sinking
<p>Position Sensors Interface</p>	<ul style="list-style-type: none"> • Four differential digital encoder interfaces • Support for selected absolute encoders (may require "Enhanced" controller option)
<p>Control Signals</p>	<p>Brake signals (Up to 1 A at 24VDC available for releasing motor brakes)</p>
<p>Communications Interfaces</p>	
<p>Serial Communication</p>	<p>RS-232 port with hardware flow control</p>
<p>MCP & E-Stop Interface</p>	<ul style="list-style-type: none"> • Second RS-232 port (without hardware flow control) for manual control pendant or general communication • Dual E-Stop interfaces

General Specification	Range & Features
Ethernet Ports	Two 10/100 Mbps Ethernet ports
Digital Input Channels	<ul style="list-style-type: none"> • Four general purpose optically isolated inputs, configurable as sinking or sourcing, signals transition to a high or low in 4 usec, 5VDC to 24VDC for logic high if sinking • 24VDC supplied for logic high if sourcing • Additional remote I/O available via PreciseFlex RIO modules, 3rd party MODBUS/TCP devices, or 3rd party EtherNet/IP devices
Digital Output Channels	<ul style="list-style-type: none"> • Four general purpose optically isolated outputs, individually configurable as sinking or sourcing, signals turn on in 3 usec and turn off within 400 usec, 24 VDC maximum pull up if sinking • 24VDC supplied if sourcing • 100 mA maximum per channel • Additional remote I/O available via PreciseFlex RIO modules, 3rd party MODBUS/TCP devices, or 3rd party EtherNet/IP devices
Multi-Drop Serial I/O	RS-485 multi-drop serial communications. Not available on controllers embedded in PreciseFlex Robots
General	
Size and Weight	150mm (L) x 87mm (W) x 38mm (H), 0.2 kg in open frame format including mounting bracket
Low Voltage Logic Power	24VDC \pm 5%, power required for logic and I/O, 2A minimum. 4A recommended for systems with remote IO, Ethernet cameras or several motors with brakes.

Guidance Controller Environmental Specifications

The Guidance Controllers must be installed in a clean, non-condensing environment with the specifications in [Table 5-13](#).

Table 5-13: Environmental Specifications

General Specification	Range & Features
Ambient temperature	5° C to 40° C
Storage and shipment temperature	-25° C to +55° C
Humidity range	5 to 90%, non-condensing
Altitude	Up to 3000 m
Free space around controller	6 mm sides and top
Chassis protection class	IP20 (NEMA Type 1)
For EU or EEA countries	IP22 minimum, must meet EN 60204 (IEC 204)

Appendix B: Frequently Asked Questions

This section contains a compilation of frequently asked questions related to the family of Guidance Controllers.

How does the user connect a robot power enable button?

To connect a momentary contact button to enable robot power, wire the button to a general digital input signal. The number of the DIN signal should be set as the "Power enable DIN" (DataID 242) parameter database value. Power will then be enabled when the signal toggles from the OFF to the ON state.

How does the user release the motor brakes in a 1 or 2-axis system?

For the integrated motor amplifiers of the Guidance Controllers, the brake signals that are presented in the four motor connectors are all tied together internally and are operated by the software that controls the 3rd axis/motor. This works correctly for 3 or 4-axis systems where the 3rd axis is the one that is affected by gravity.

If your system only has one or two axes, to configure the first or second axis to control the brake signals, set the "Auxiliary brake release DOUT channel" (DataID 10625) Parameter Database value for the appropriate axis to "8331." "8331" is the DOUT channel number for the dedicated DIO that controls the brake signal.

Why should grippers be wired to release when digital signals are ON?

Grippers or other tooling should always be wired to digital output signals such that an active (ON) state will release a part. This is an important practice since if the controller loses power and is restarted, all output signals are turned OFF by default. If a gripper is wired to release a part with an OFF signal, any parts left in a gripper from a previous operation would be dropped when the controller is restarted.

What are the restrictions on assigning encoder and amplifier channels?

Due to restrictions in the controller's firmware, in general, the encoder signals used to commutate a motor must be connected to the encoder connector that matches the amplifier connector for the motor. For example, if the leads of a motor are wired to the 2nd amplifier connector, the encoder that commutates the motor must be wired to an input of the 2nd encoder connector. (For all

configurations except for dual-loop encoders, a single encoder is utilized to both commutate the motor and close the PID loop.)

For incremental quadrature encoders, the encoder can be interface to either the differential or the single-ended encoder inputs of the required encoder connector. However, the differential inputs are strongly recommended due to their much greater noise immunity.

For the first four serial absolute encoders, encoders from different manufacturers must be connected to specific pins in the required encoder connectors (see the Controller's ["Third Party Equipment: Overview" on page 52](#) for more details).

For a 6-axis controller, the absolute encoders for the 5th and 6th motors must be connected to specific pins in the 1st and 2nd encoder connectors, respectively.

Once encoders and motors have been properly wired to controller connectors, the encoder and motor pair can be arbitrarily mapped to logical axes of a robot. For example, an encoder and motor can be wired to the 4th encoder and motor connectors, but can be assigned to the 2nd axis of a kinematic module.